

















ATA ve ATZ serisi

- Yüksek tartım doğruluğu
- Kompakt yeni tasarım
- Yüksek çözünürlüklü LCD ekran
- Otomatik kalibrasyon (ATA)
- RS232C yazıcı, bilgisayar veya barkod okuyucu



ATA ve ATZ serisi laboratuvar terazileri, yüksek ölçüm doğruluğunun ve kompakt boyutun gerekli olduğu laboratuvarlar, eczaneler, kuyumculuk ve araştırma enstitülerinde kullanılmak üzere tasarlanmıştır.

 harici kalibrasyon	 çıktı yapılandırma	 birim seçimi	 canlı hayvan tartımı
 dahili kalibrasyon	 adet sayma	 filtreleme seçenekleri	 yoğunluk ölçme
 GLP uyumluluk	 yüzdeme	 tartım noktası seçimi	 kuvvet ölçme
	 toplama	 max ağırlık	 reçeteleme
		 min ağırlık	 istatistik

Standart ve Opsiyonlar



Alttan tartım
standart



Portatif rüzgarlık
standart



Yoğunluk kiti
opsiyonel



Harici ekran
opsiyonel



Tarih/Saat
standart



ALIBI memory
standart

Alttan tartım kancası

Portatif rüzgarlık

Hydro AKA "kit" katı ve sıvı yoğunluğunu ölçmek için (sadece kefe çapı 115mm olan cihazlarda)

Dahili tarih/saat (tarih ve saat çıktısı alınabilir)

Tartım hafızası (Alibi)

LAN veya Wi-Fi bağlantıları

Harici ekran

Barkod okuyucu (RS232 bağlantısı ile)

Bilgisayar programı: **Statistics** ücretsiz, Pc iletişimi için ücretsiz

- Dosyaya kaydetme "ProCell"
- Excel'e aktarabilme

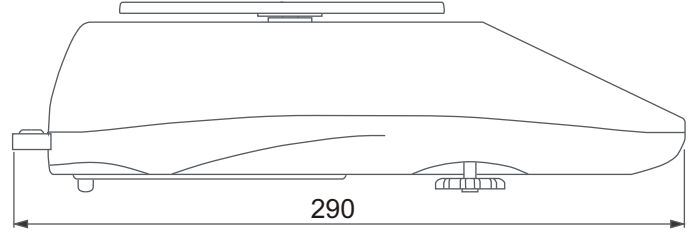
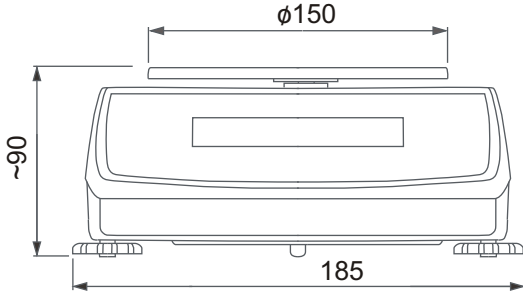
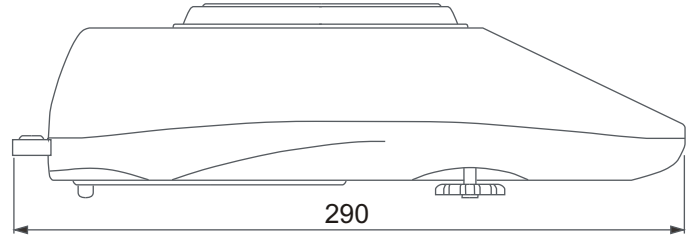
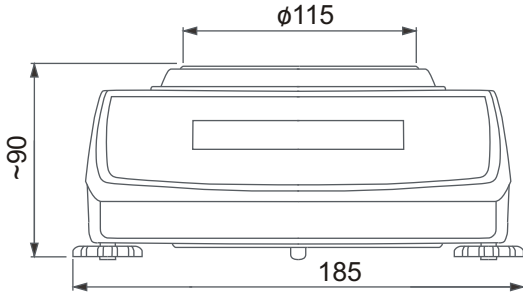

Teknik özellikler:

Model	ATA520	ATA2200	ATZ520	ATZ2200
Kapasite (Max)	520g	2200g	520g	2200g
Okunabilirlik (d)	0,001g	0,01g	0,001g	0,01g
Doğrulanabilirlik (e)	0,01g	0,1g	0,01g	0,1g
Dara aralığı	-520g	-2200g	-520g	-2200g
Onay sınıfı	II			
Tekrarlanabilirlik	0,001g	0,01g	0,001g	0,01g
Lineer	±0,002g	±0,02g	±0,002g	±0,02g
Çalışma sıcaklığı	+10 ÷ +40°C			
Hassasiyet kayması	2 ppm/°C +15 ÷ +35°C			
Stabilizasyon süresi	<3s	<2s	<3s	<2s
Kefe boyutu	φ 150mm	φ 150mm	φ 150mm	φ 150mm
Ekran	LCD ekran			
Boyutlar (ayaklar ile birlikte)	185x290x90mm			
Arabirimler	RS232C, USB_B; opsiyon: LAN veya Wi-Fi		RS232C; opsiyon: USB_B, LAN veya Wi-Fi	
Birimler	mg, g, kg, ct, lb, oz, ozt, gr, dwt ~230V			
Güç kaynağı	50Hz 6VA/ =12V 1,2A			
Terazi ağırlığı	2,6kg		2,1kg	
Otomatik kalibrasyon	√	√	-	-
Önerilen kalib. ağırlıkları	F1 500g	F2 2000g	F1 500g	F2 2000g