















BTA serisi

- Kompakt ve ekonomik
- Mobil kullanım imkanı (Pil & Akü)
- Kolay kullanılabilirlik
- Alttan tartım & Tartım modları
- Yazıcı ve bilgisayar bağlantısı



BTA serisi teraziler, hafif sanayi koşullarında, depolarda ve ayıklama tesislerinde kullanılmak üzere istenildiğinde mobil çalışmaya uygun olarak tasarlanmıştır.

 harici kalibrasyon	 ürün kayıtları	 birim seçimi	 canlı hayvan tartımı
 GLP uyumluluk	 çıktı yapılandırma	 tartım noktası seçimi	 kuvvet ölçme
	 adet sayma	 max ağırlık	 reçeteleme
	 yüzdeme	 min ağırlık	 istatistik
	 toplama		

Standart ve Opsiyonlar



Pil yuvası ve pilleri

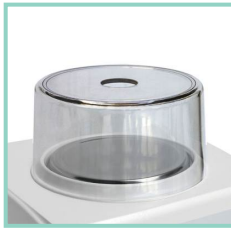

Portatif rüzgarlık



Tarih/saat



ALIBI hafıza

Pil ile çalışması imkanı (standart)

Portatif rüzgarlık (standart)

Tarih&saat (opsiyon)

ALIBI hafıza (opsiyon)

LAN veya Wi-Fi bağlantısı (opsiyon)

RS232C bağlantı portu (standart)

Bilgisayar programı : Statistics ücretsiz

, PC iletişimi için ücretsiz

- Dosyaya kaydetme "ProCell"

- Excele aktarma

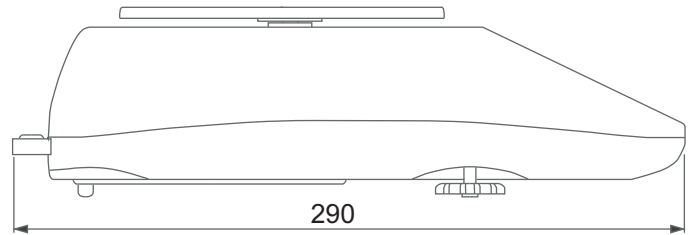
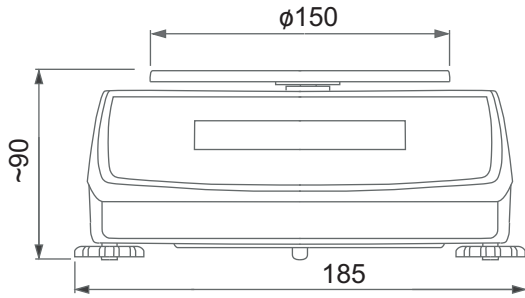
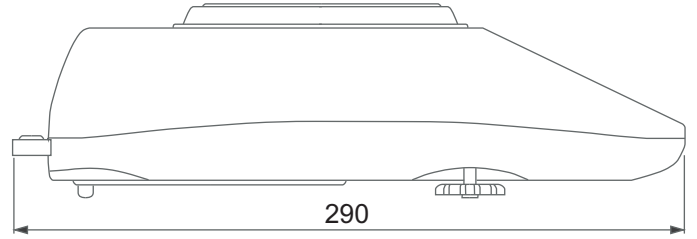
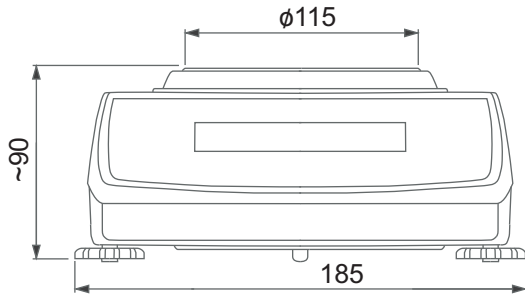

Teknik özellikler:

Model	BTA210D	BTA300D	BTA2100D	BTA3000D
Kapasite (Max)	210g	300g	2100g	3000g
Okunabilirlik(d)	0,001g	0,001g	0,01g	0,01g
Dara aralığı	Maks.	Maks.	Maks.	Maks.
Tekrarlanabilirlik	0,003g	0,003g	0,03g	0,03g
Kefe boyutu	1 15mm	1 15mm	150mm	150mm
Çalışma sıcaklığı	+18 ÷ +35°C			
Stabilizasyon süresi	<3s			
Ekran	LCD			
Boyutlar	mg, g, kg, ct, lb, oz, ozt, gr, dwt			
Pil ile çalışma süresi	~6s (ışık açıkken), ~16s (ışık kapalıyken)			
Akü şarj göstergesi	✓			
Otomatik kapanma fonksiyonu	✓ (5dk. sonra)			
Ekran aydınlatma oto. kapanma	✓ (30 s. sonra)			
Arabirimler	Standart: RS232C Opsiyon: USB_B			
Tartım birimleri	g, kg, ct, lb, oz, ozt, gr, dwt			
Güç kaynağı	~230V 50Hz 6VA / =12V 1,2A veya 4xAA (pil)			
Terazi ağırlığı	1,3kg			
Önerilen kalib. ağırlıkları	M1 200g	F2 200g	M1 2000g	F2 2000g