



USER MANUAL

ACA/G, ACZ/G SERIES

Contents:

1.	General description	3
2.	Set	3
3.	Safety rules.....	4
4.	Technical data	5
5.	General balance description	6
6.	Keys and indicators.....	8
7.	Preparing working environment	10
8.	Preparing balance to work.....	11
9.	General operation principles	12
10.	Start-up.....	13
11.	Internal calibration (only ALN/G).....	13
12.	Checking the balance.....	15
13.	Connecting the balance to computer or printer.....	15
14.	Menu navigation	19
15.	Setup	20
15.1	User – Log in and add users	21
15.2	Application selection – creating personalized menu	23
15.3	Calibration with external weight / calibration options	24
15.4	Auto-zeroing function.....	28
15.5	Unit selection	28
15.6	Interface parameters setting.....	30
15.7	Print setup.....	31
15.8	LCD settings	34
15.9	Language selection.....	34
15.10	Setting date and time.....	35
15.11	Keyboard options.....	35
15.12	Analog output.....	36
15.13	Speed.....	36
16.	Applications	37
16.1	Product database.....	38
16.2	Pieces counting.....	40
16.3	Unit.....	41
16.4	Percentage.....	42
16.5	Animals weighing.....	43
16.6	Tare setting.....	44
16.7	Max or minimum value indication	45
16.8	Force indication (Newton).....	46
16.9	Total.....	47
16.10	Checkweighing function (thr).....	48
16.11	Stats.....	51
16.12	Paper grammage calculation (option)	54
16.13	Density determination	55
16.14	Recipe.....	59
17.	Measurements.....	60
18.	Detailed information about balance communication	61
18.1	Long protocol description.....	61
18.2	Protocol EPL description	63
19.	Troubleshooting and maintenance.....	64

1. General description

ACA/G and ACZ/G series balances are destined for high accuracy weighing in laboratory practice. Balances are equipped with graphical display and internal calibration system (only ACA/G) for accuracy control during balance operations. ACZ/G have only external calibration option. Electronics system is based on new generation 32-bit microprocessor.

SPEED option enables to change weighing speed and adjust it to measurement conditions.

All balances are metrologically tested. According to an order balances can be calibrated or legally verified.

Balances with legal verification comply with certificate of type approval and are marked with the following legal and securing items:

- metrological mark placed on the balance name plate,
- notified body stamp (number of notified body) on the balance name plate,
- protective seals placed on: an edge of balance name plate, the casing mounting screw and in the place of access to adjustment switch,

In order to renew legal verification please contact authorized service of AXIS.

Balance classification according to PKWiU: 33.20.31.

Certificates:

2. Set

A standard set consist of:

1. Balance,
2. Pan support and decorative pan,
3. Feeder 12V / 1,2A,
4. User manual,
5. Guarantee card

3. Safety rules

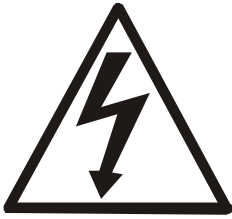

It is necessary to follow safety rules of work with the balance shown below. Obeying those rules is the condition to avoid electrical shock or damage of the balance or connected peripheral devices.

- Repairs and necessary regulations can be done by authorised personnel only.
- To avoid fire risk use a feeder of an appropriate type (supplied with the balance) and supply voltage have to be compatible with specified technical data.
- Do not use the balance when its cover is opened.
- Do not use the balance in explosive conditions.
- Do not use the balance in high humidity environment.
- If the balance seems not to operate properly, switch it off and do not use until checked by authorised service.



According to current acts of law about protection of natural environment, wasted balances should not be put into waste containers together with ordinary waste.

- Wasted balance after operation period can be delivered to units authorized for gathering wasted electronic devices or to the place where it was bought.

4. Technical data

Balance type	ACA220G ACZ220G	ACA320G ACZ320G	ACA520G ACZ520G	ACA620G ACZ620G	ACA820G ACZ820G	ACA1000G ACZ1020G
Max load (Max)	120g	220g	320g	520g	820g	1000g lub 1020g
Min load (Min)	0,2g	0,2g	0,2g	0,2g	0,2g	0,2g
Readout unit (d)	0,001g	0,001g	0,001g	0,001g	0,001g	0,001g
Verification unit (e)	0,01g	0,01g	0,01g	0,01g	0,01g	0,01g
Tare range	-120g	-220g	-302g	-520g	-820g	-1000g lub 1020g
Accuracy class	II					
Repeatability	0,001mg					
Linearity	$\pm 0,002$ mg					
Work temp.	$+10 \div +40^{\circ}\text{C}$					
Weighing time	<3s					
Pan size	$\phi 115$ mm					
Dimensions (with legs)	215(235 with legs)x345x90mm					
Interfaces	RS232C, USB_A, USB_B, clock (optional: LAN or Wi-Fi)					
Supply	~230V 50Hz 6VA / =12V 1,2A					
Balance weight	4kg					
Recommended standard of mass	F2 200g	F2 200g	F2 500g			F2 1000g
Balance type	ACA2200G ACZ2200G	ACA3200G ACZ3200G	ACA4200G ACZ4200G	ACA6200G ACZ6200G		
Max load (Max)	2200g	3200g	4200g	6200g		
Minimal load (Min)	2g	2g	2g	2g		
Readout unit (d)	0,01g	0,01g	0,01g	0,01g		
Verification unit (e)	0,1g	0,1g	0,1g	0,1g		
Tare range	-2200g	-3200g	-4200g	-6200g		
Accuracy class	II					
Repeatability	0,01mg			0,02mg		
Linearity	$\pm 0,02$ mg					
Work temp.	$+10 \div +40^{\circ}\text{C}$					
Weighing time	<3s					
Pan size	$\phi 115$ mm					
Dimensions (with legs)	215(235 with legs)x345x90mm					
Interfaces	RS232C, USB_A, USB_B, clock (optional: LAN or Wi-Fi)					
Supply	~230V 50Hz 6VA / =12V 1,2A					
Balance weight	4kg					
Recommended standard of mass	F2 2000g			F2 5000g		

5. General balance description

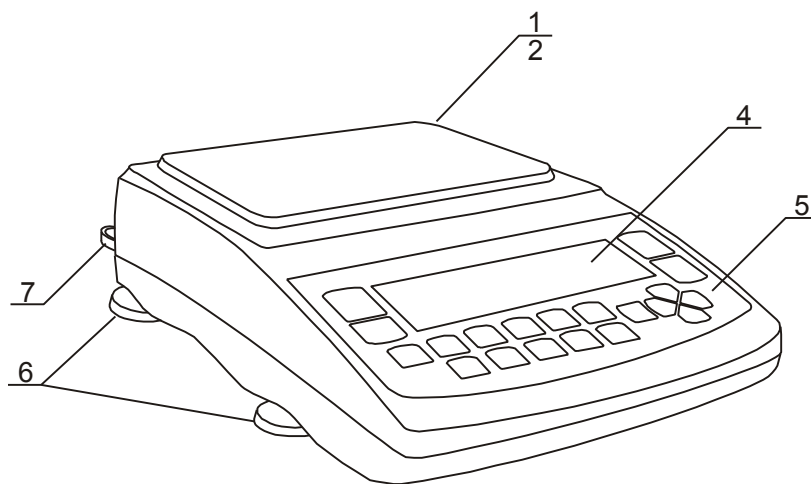
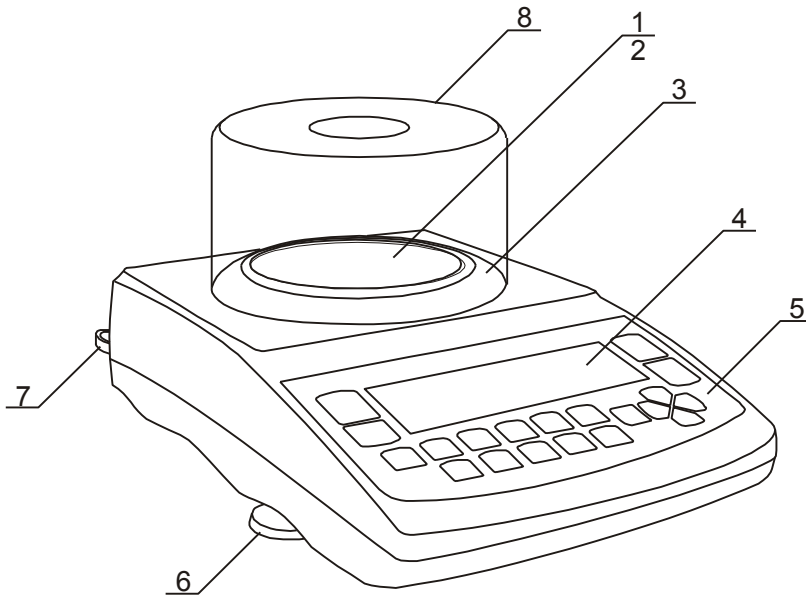

Connectors view:

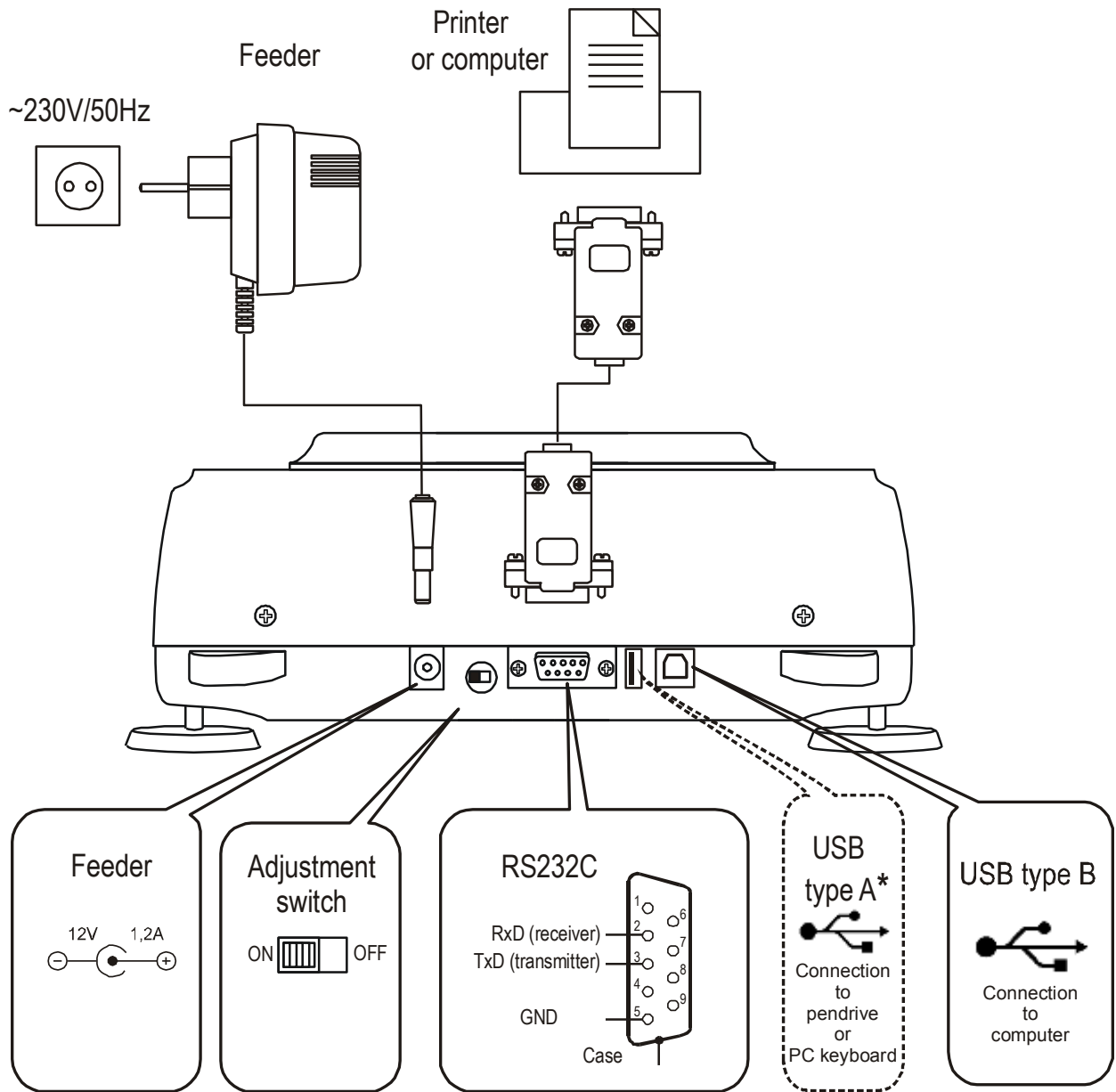

* USB type A is a optional interface on demand

6. Keys and indicators



Basic functions:

→T←	- tare (enter mass subtracted from weighed mass)
→0←	- zeroing (option),
ENTER	- confirmation / entering option,
.	- decimal point / log in user
1 / F1 ... 5 / F5	- alphanumeric keys /programmable shortcuts to apps,
6 / →0←	- numerical key / zeroing (only scale for trade),
7 / ↵	- numerical key / printout (transmission) / hold longer to view print menu,
8 / ▼	- numerical key / internal calibration,
9 / MENU	- numerical key / enter menu,
0 / ↻	- numerical key / balance mode switching,
∧, ∨, >, <	- navigation keys,
CLR	- back/cancel last operation,
I / ⏻	- turn on / turn off (standby),

The use of keys during entering numeric values (special functions):

↑ - increasing displayed digit or when pressed longer decimal dot

↓ - decreasing displayed digit

→ - move cursor to right (**next digit**)

← - move cursor to left (**previous digit**)

ENTER - confirmation / end of inscribing

CLR - cancel

Extended functions of numerical keys when entering data:

1	1 _ (space)
2	2 A B C a b c
3	3 D E F d e f
4	4 G H I g h i
5	5 J K L j k l
6	6 M N O m n o
7	7 P Q R S p q r s
8	8 T U V t u v
9	9 W X Y Z w x y z
0	0 . , ' ? ! , , - () @ / : _ ; + & % * = < > \$ { } { } \ ~ #

After selecting menu option that enables entering data a cursor will show up. Repeated pressing of numerical key changes the alphanumeric sign. List of signs on the upper part of the screen changes. Erasing last sign by pressing < key, erasing whole line - *Clr* key.

7. Preparing working environment

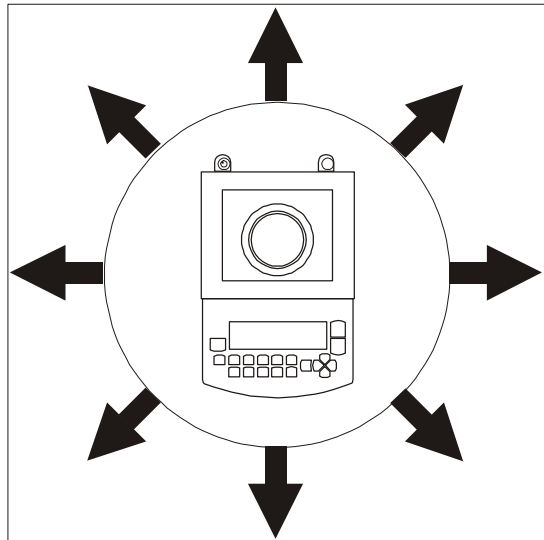
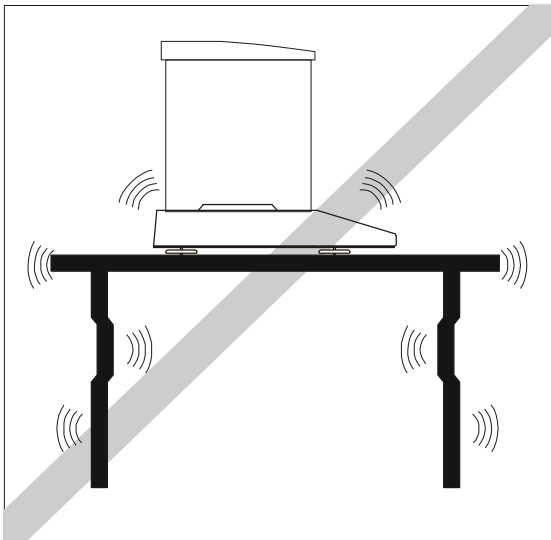
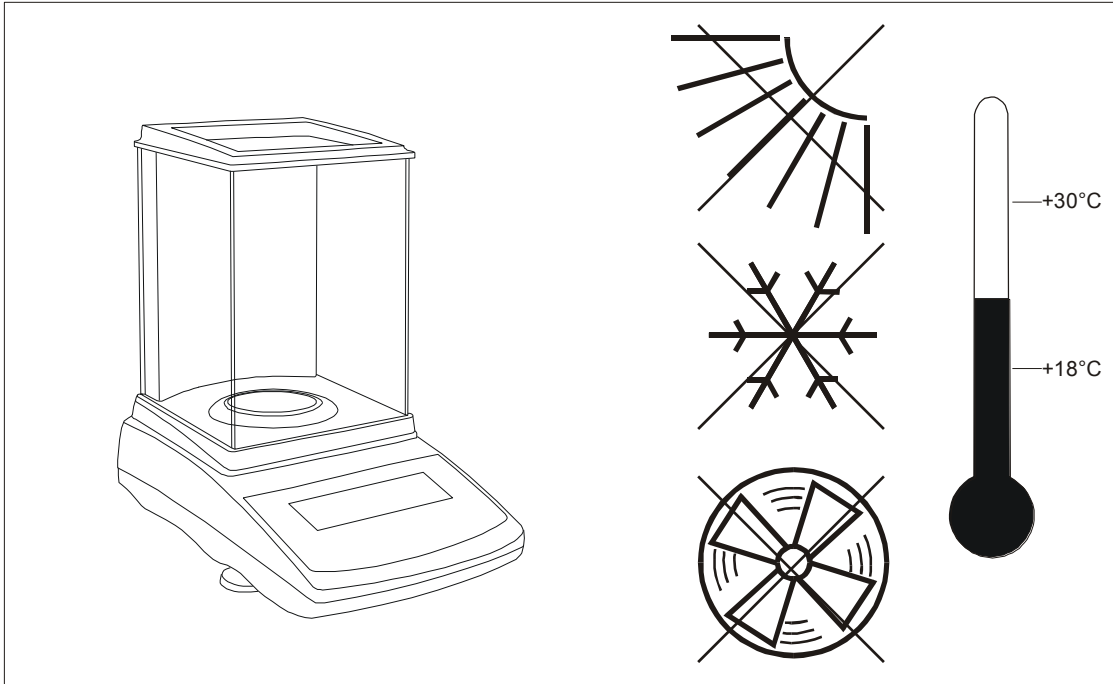

Location for the balance should be chosen with care in order to limit influence of the factors that can interrupt working balance. This location has to maintain proper temperature for working balance and necessary space for its operating. The balance should stay on stable table made of material that does not influence magnetically on the balance.

Rapid air blasts, vibrations, dust, rapid temperature changes or air humidity over 75% are not allowed in balance surrounding. The balance should be far from heat sources and devices emitting strong electromagnetic or magnetic fields.

8. Preparing balance to work

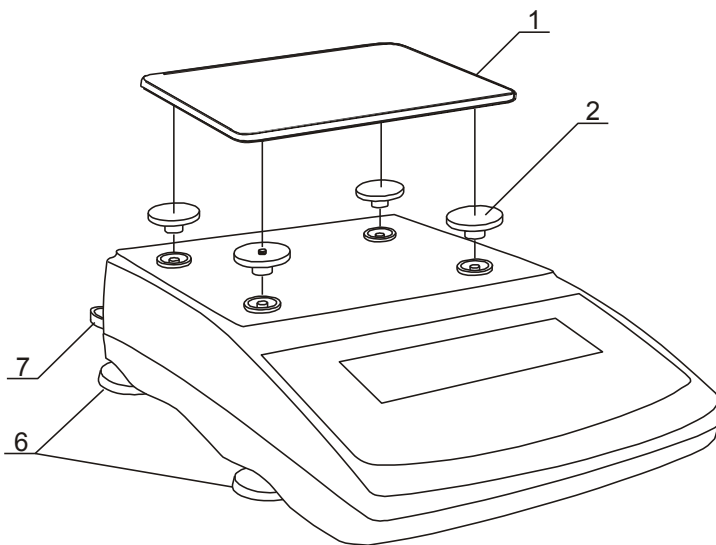
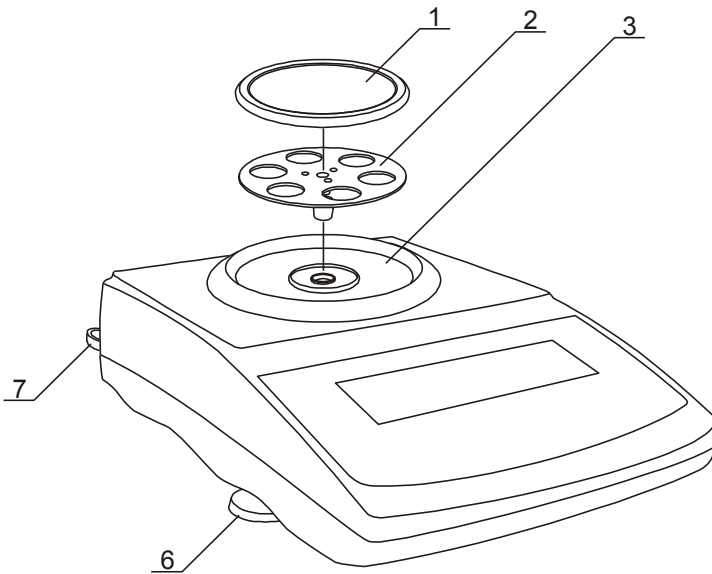

1. Take the balance, the feeder and mechanical elements of the pan out. It is recommended to keep the original scale package in order to transport the balance safely in future.

2. Place the balance on a stable ground not affected by mechanical vibrations and airflows.

3. Level the balance with rotating legs 6 so that the air bubble in water level 7 at the back of the balance is in the middle.

4. (for AGC100-AGC600) Gently insert the mandrel of pan support 2 into balance mechanism socket through the pan ring 3 and the pan 1 on (AGC600 balances have not pan ring).

5. (for AGC1000-AGC4000, AGZ10C) Place nuts 2 on mandrels that are visible in balance cover holes, put the pan 1 on nuts.



If the balance was taken from a lower temperature surrounding to a room with higher temperature, e.g. in winter, moisture can liquefy on the balance casing. Do not connect power supply to the balance, because this can cause damage or improper work of the balance. In this case leave the balance for at least 4 hours unplugged for acclimatization.

9. General operation principles



Do not overload the balance more than 20% of maximum capacity.
Do not press the pan with a hand.



For transportation take off the pan (move it gently and lift it up) and pan support (lift it up) and protect from any damages.

1. Weighed sample should be placed in the centre of the pan.
2. Weighing result should be read when the indicator "▲▲" lights, which signals stabilisation of a result.
3. The balance allows tarring in the whole measuring range. To tare the balance press $\rightarrow T \leftarrow$ key (on the left or on the right). Tarring does not extend measuring range, but only subtracts tare value from mass value of a sample placed on the pan. To make the control of pan load easier and to avoid crossing measurement range, the balance has a load indicator calibrated 0÷100% Max.
4. In direct sale use (d=e), make sure that $\square 0$ zero indicator is displayed before sample is placed on the pan. If not, press $\square 0$ key and wait until the balance is zeroed and zero indicator appears. In other balances the key does not operate.
5. When the balance is not used but should be ready to work immediately, it can be switched off by pressing I/ϕ key. The backlight of balance reading system is then switched off and the balance enters into "standby" mode, in which the balance maintains internal temperature and ability to start working with maximum accuracy. Standby mode is signalled by the *OFF* indicator. To switch the balance on press I/ϕ key.
6. The balance cannot be used to weigh ferromagnetic materials due to decrease of weighing accuracy.
7. Balance mechanism is a precise device sensitive to mechanical shocks and strokes.
8. After every change of balance position, level the balance and perform internal calibration using \blacktriangledown key.

10. Start-up

Plug feeder into 230V power supply socket and feeder output connector into 12V socket at back of the balance.



After switching-on, the balance displays AXIS logo and performs automatic self-tests.

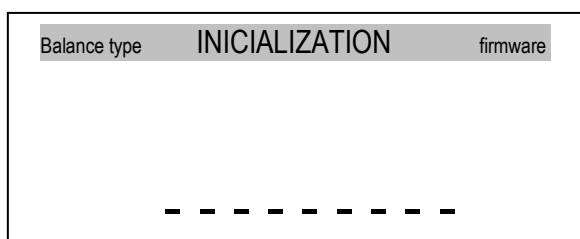

In case of test failure balance displays tests list. Lack of ✓ mark means negative test result.

Afterwards the balance enters automatically into internal calibration mode, which is described with details in next chapter. Calibration can be terminated using *CLR* key.

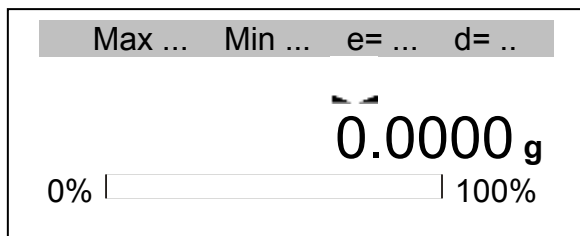
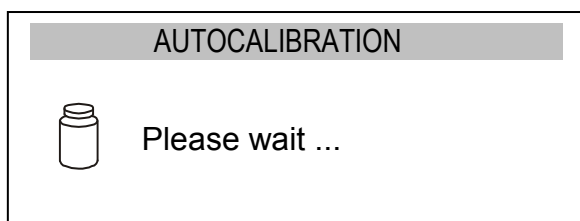

When internal calibration is finished, the balance enters into normal weighing mode.

11. Internal calibration (only ACA/G)

The balance is equipped with internal calibration system, which general task is to maintain required measurement accuracy of the balance.

Internal calibration is the process of putting internal weight on automatically by balance mechanism and correcting accuracy in balance firmware. The correction is necessary because of differences between values of gravitational acceleration in the place where the balance was manufactured and in the place where it is operated, as well as due to changes of balance level and temperature.

Internal calibration is performed in the following situations:

- when ▼ key is pressed,
- first 30 minutes after turning on the balance is the time when the electronics heat up and internal calibration may be automatically performed to maintain high level of precision,

Internal calibration should be performed

- after defined time interval (for legally verified balances - 2 hours) – the balance will show up alternately CAL symbol instead of — — stabilization mark to remind user that internal calibration should be performed (user should press ▼ key),
- after temperature change (for legally verified balances – more than 2°C) – the balance will show up alternately CAL symbol instead of — — stabilization mark to remind user that internal calibration should be performed (user should press ▼ key).

In legally verified balances time interval is set to 2 hours and defined temperature change is 2°C. In not legally verified balances those values can be set as calibration options.

In order to perform internal calibration proceed with the following actions:

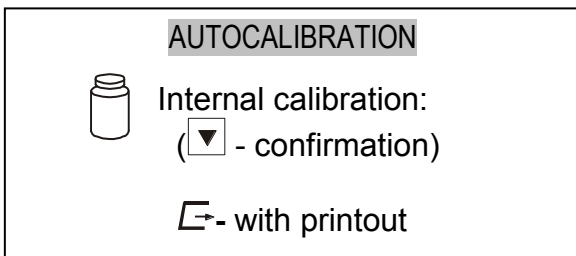

Empty the pan.

Press ▼ key and you will have two options:

- if you will press a second time ▼ key then the internal calibration will start (double pressing the key helps to avoid accidental starting calibration procedure),
- if you will press ↵ key then calibration with printout will start (calibration data will be sent to printer/computer).

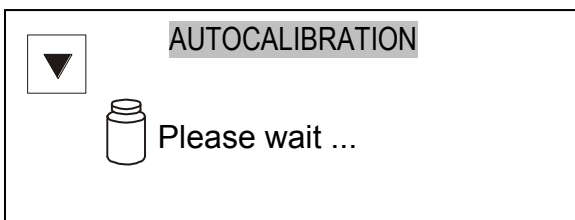

During calibration internal weight is put three times on and obtained results are compared.

Discrepancy of results is signalled with a message and causes the balance being blocked.

Until calibration process is finished do not perform any operation on the balance. Any vibrations and shocks interfere calibration process and may delay it or deteriorate accuracy of its result.

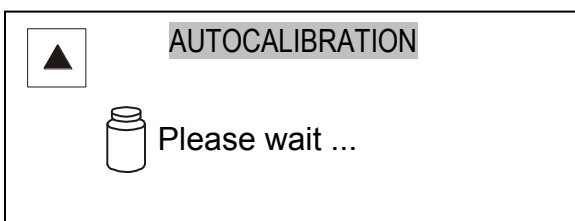

When internal calibration is performed successfully the balance indicates zero on the display at empty pan.

Note:

In order to terminate calibration process press CLR key and wait until balance mechanism is not settled in initial position.

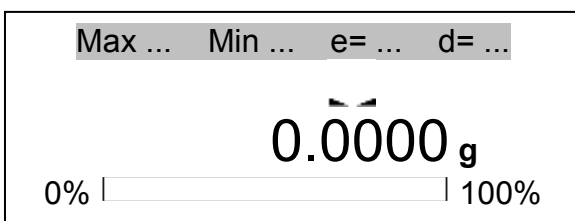

12. Checking the balance

In order to confirm correctness of the balance during its operation, before starting and after finishing every measurement series it is advised to check weighing accuracy. It can be done by weighing external calibration weight or other object with exactly known mass.

If exceeding of allowable measurement error is affirmed, the following things should be checked:

- if the balance stands stable and it is levelled,
- if the balance is exposed on rapid air blasts, vibrations, rapid temperature changes or air humidity,
- if the balance is not affected directly by heat source, electromagnetic radiation or magnetic field.



The cause of inaccuracy can be too low temperature of the balance as well, when it was unplugged from power supply. In this situation leave the balance switched on for several minutes in order to adjust its internal temperature.

If none of above causes of inaccuracy occurs, calibration with external weight should be performed to the balance. Recommended external calibration weight (to buy for additional charge) is given in technical data table. In order to calibrate the balance with external weight in legally verified balances verification seals should be removed and another legal verification should be performed. In this case it is recommended to contact authorized service centre.

Calibration with external weight is described in details in chapter 17.1.

13. Connecting the balance to computer or printer

The scale can be equipped with two or three serial interfaces RS232C, USB_B, USB_A, LAN or Wi-Fi designed to cooperate:

- with computer – the scale sends data after pressing  key or after initiation signal from computer,
- with printer - sending data after pressing  key or automatically after putting on/off a sample and measurement stabilization,
- with label printer – after pressing  the scale sends set of instructions for label printer starting from label number set in special function *LabEL*.
- with flash memory stick (pendrive) or PC keyboard – only USB_A.

Set of send data is set using special function *Print*.

The following data can be send:

- Header (scale type, Max, d, e, serial number),
- Operator identification number,
- Successive printout number (measurement),
- Identification number or product bar code,
- Number of pcs (PCS function only),
- Single detail mass (PCS function only),
- Nett weight,
- Tare (package mass),
- Gross weight,
- Total mass (Total function only).

The way of sending data and transmission parameters is set using *SERIAL* special function.

If the scale is equipped with two serial joints (interfaces) *Print* and *SERIAL* function is set independently for both interfaces.

If scale cooperates with a computer then the computer must have a special program. Dedicated programs are also offered by AXIS.

Needed drivers and instructions can be found on the CD supplied with Axis scales.

12.1 Detailed LonG protocol description

Standard communication parameters: 8 bits, 1 stop bit, no parity, baud rate 9600bps,

After using  key, measurement data is send together with text description (NET, TARE, GROSS) – all set by using *Print* option. If *Print* isn't set then only scale indication is send (as below).

Data exchange (communication):

- Readout of scale indication

Computer→Scale: **S I** CR LF (53h 49h 0Dh 0Ah),

Scale→Computer: scale response according to description below (16 bytes):

Byte	1	-	sign „-“ or space
Byte	2	-	space
Byte	3÷4	-	digit or space
Byte	5÷9	-	digit, decimal point or space
Byte	10	-	digit
Byte	11	-	space
Byte	12	-	k, l, c, p or space
Byte	13	-	g, b, t, c or %
Byte	14	-	space
Byte	15	-	CR
Byte	16	-	LF

Attention:

Network number different than zero (*SERIAL / nr* function) changes scale working mode: communication with a computer is possible after logging the scale in with 02h scale number command. To log the scale out use 03h command.

For example: Using a program to test RS232 interface (program is available in www.axis.pl / [programy komputerowe](#)) for scale number 1 please write: \$0201 to log in, then SI, and write: \$03 to close communication.

- Asking about scale presence in system (testing scale connection with computer):

Computer→Scale: S J CR LF (53h 4Ah 0Dh 0Ah),

Scale→Computer: M J CR LF (4Dh 4Ah 0Dh 0Ah),

- Displaying a inscription on scale's display (text communicate from computer):

Computer→Scale: S N n n X X X X X X CR LF, nn-displaying time in seconds; XXXXXX-6 signs to display

Scale→Computer: M N CR LF (4Dh 4Eh 0Dh 0Ah),

- Scale tarring (calling →T← key press) :

Computer→Scale: S T CR LF (53h 54h 0Dh 0Ah),

Scale→Computer: without response,

- Scale zeroing (calling $\rightarrow 0 \leftarrow$ key press):
Computer \rightarrow Scale: **S Z** CR LF (53h 5Ah 0Dh 0Ah),
Scale \rightarrow Computer: without response,
- Scale turning on / off (calling I/⏻ key press):
Computer \rightarrow Scale: **S S** CR LF (53h 53h 0Dh 0Ah),
Scale \rightarrow Computer: without response,
- Entering to special function menu (calling MENU key press):
Computer \rightarrow Scale: **S F** CR LF (53h 46h 0Dh 0Ah),
Scale \rightarrow Computer: without response,
- Setting threshold 1 value (option):
Computer \rightarrow Scale: **S L D1...DN** CR LF (53h 4Ch D1...DN 0Dh 0Ah)
D1...DN – threshold value, maximum 8 characters („-” – negative value, digits, dot – decimal separator), number of digits after dot should be the same as on scale display,
Scale \rightarrow Computer: without response,
Example:
 - in order to set low threshold 1000g in scale B1.5 (d=0.5g) the following order should be sent:
S L 1 0 0 0 . 0 CR LF (53h 4Ch 31h 30h 30h 30h 2Eh 30h 0Dh 0Ah),
 - in order to set low threshold 100kg in scale B150 (d=50g) the following order should be sent:
S L 1 0 0 . 0 0 CR LF (53h 4Ch 31h 30h 30h 2Eh 30h 30h 0Dh 0Ah),,
- Setting threshold 2 value (option):
Computer \rightarrow Scale: **S H D1...DN** CR LF (53h 48h D1...DN 0Dh 0Ah),
D1...DN – threshold value, maximum 8 characters
Scale \rightarrow Computer: without response.
- Setting threshold 3 value (option):
Komputer \rightarrow Waga: **S M D1...DN** CR LF (53h 4Dh D1...DN 0Dh 0Ah),
gdzie: D1...DN – threshold value, maximum 8 characters
Waga \rightarrow Komputer: without response.

Connecting cable WK-1 (scale – computer / 9-pin interface):

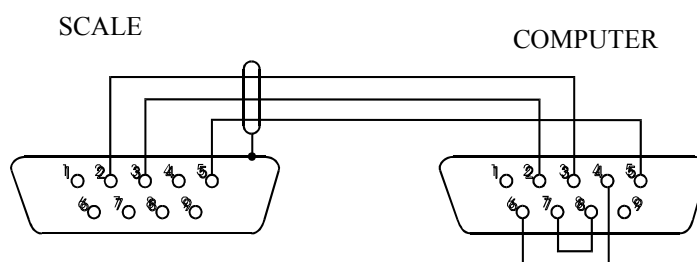

12.2 Detailed EPL protocol description

Transmission parameters: 8 bits, 1 stop bit, no parity, baud rate 9600bps,

- After using  key in scale:
- Scale→Label printer : set of instruction in EPL-2 language that initialize label printing:

US	- Steering instruction
FR"0001"	- Label number define instruction
?	- Instruction that starts list of variable signs
mm:gg	- 5 signs: minutes:hour
rrrr.mm.dd	- 10 signs: year.month.day
masa	- 10 signs: scale indication+ mass unit
P1	- Steering instruction

Attention:

1. Except variable signs constant signs can also be inscribed e.g. factory name, product name and so on.
2. In standard only one label pattern is possible to printout (number 0001). Using bigger amount of patterns (other label numbers) is possible thanks to *LAbEL* special function.
3. To achieve label printout, label printer must have inscribed label pattern (label pattern is created on computer and using computer it is saved to label printer memory). Label pattern is designed by ZEBRA DESIGNER program which is supplied together with label printer.
4. Scales parameters and transmission protocol must correspond to label printer type.

14. Menu navigation

Balance's display during weighing:

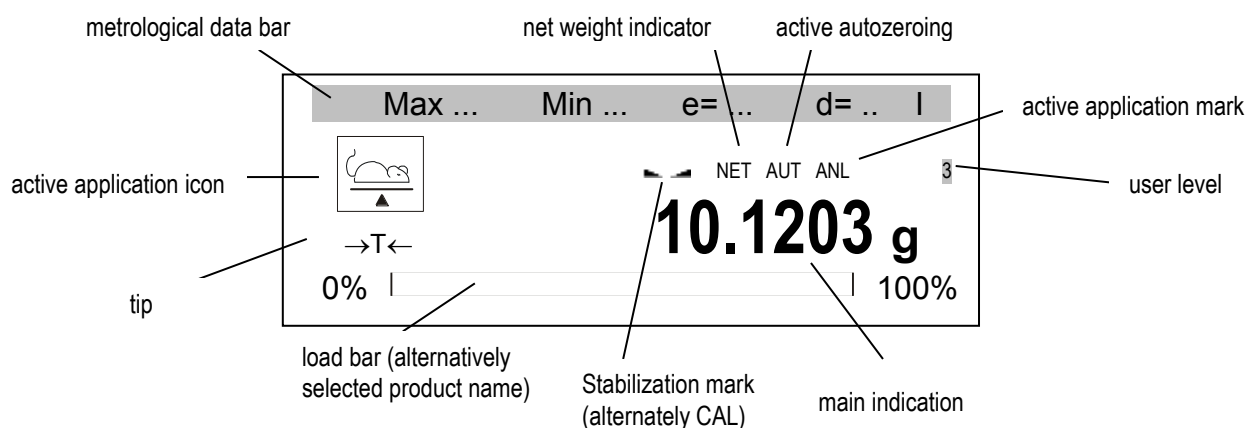

After pressing *MENU* key main menu shows up:

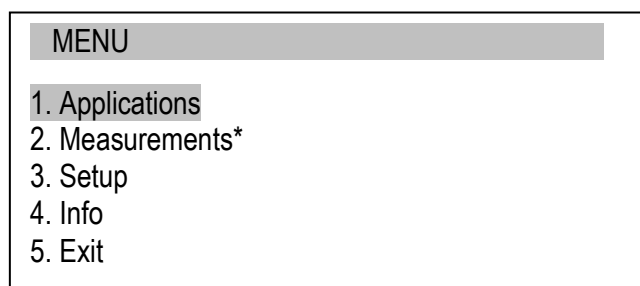

Main menu consists:

- Applications – user personalized applications menu,
- Measurements* – shows up only in balances with optional ALIBI memory and enables to view last 1000 measurements,
- Setup – creating personalized menu, calibration, balance options,
- Info – information about the balance,
- Exit

To navigate following keys are used:

- ^ - move cursor up,
- v - move cursor down,
- > - enter option, choosing/scrolling suboption,
- < - exit actual option, choosing/scrolling suboption,
- ENTER - enter / option selection,
- CLR - exit actual option (undo last operation, auto-calibration stop),
- MENU - enter/exit from menu,
- ↻ - turned on/off active application,

To use option or to choose application move cursor and press ENTER key.

Important tool to navigate are fast access keys, which are assigned by user. The keys enable direct activation off chosen 5 applications by using F1, F2, ..., and F5 key.

15. Setup

Setup consists all options used for setting balance's way of working:

MENU
1. Applications
2. Measurements*
3. Setup
3. Info
4. Exit

SETUP
1. User
2. Menu
3. Calibration
4. Auto-zeroing
5. Unit
6. Interface
7. Print setup
8. LCD settings
9. Language
10. Time&date
11. Keyboard
12. Analog output
13. Speed
14. Firmware update

User – Log-in and create users,

Menu – applications selection to user's personalized menu,

Calibration – balance's calibration,

Auto-zeroing – automatic zero indication hold when pan is unloaded,

Unit – weight unit selection,

Interface – setting serial ports,

Print setup – data selection for transmission (printout),

Time&date – inscribing actual date and time,

Keyboard – keys options,

Analog out – 4-20mA (0-10V) out configuration (option),

Firmware update – firmware actualization (only for service),

Defaults – back to factory settings,

Exit.

Attention:

Using *Defaults* option doesn't change basic metrological balance parameters like: sensitivity, linearity (if the calibration switch isn't moved), but all other settings that have influence on balance's work and communication with other devices can be changed and need resetting by User.

15.1 User – Log in and add users

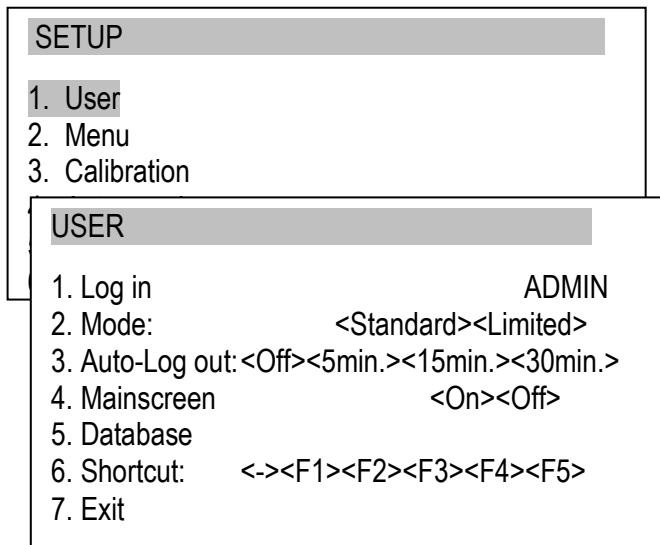

Log in – option enters list of users and enables to log in,

Mode - For „Standard” setting any user ID can be inscribed - the lowest level of privileges (user level) is assigned. For setting „Limited” only defined previously user can be selected,

Auto-Log out – option enables automatic user log out if the device isn’t used for the selected time,

Mainscreen – option enables to activate on main balance screen (during weighing) user level symbol,

Database – enables to add, edit or delete user,

Shortcut – set fast access key for login user.

Log in user

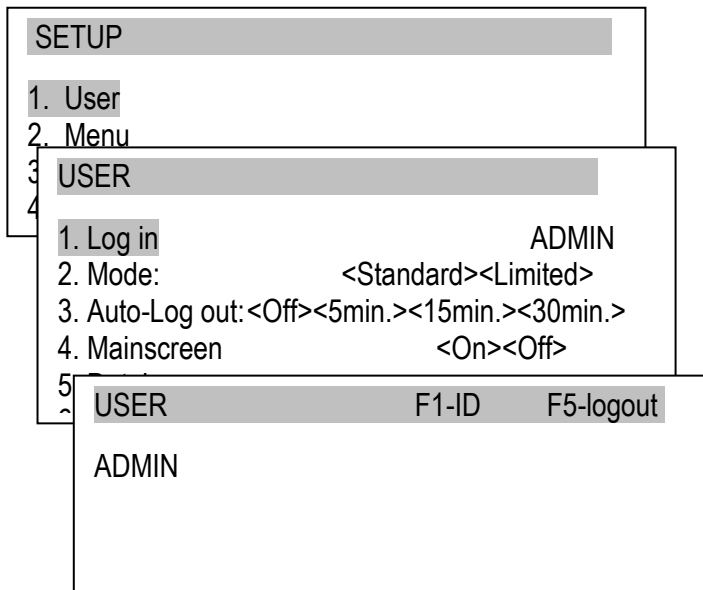

Log in is possible after:

- pressing *User* and *Log in* option
- pressing  key while the display shows weight,

List of users will show up.

In default no user exists.

or

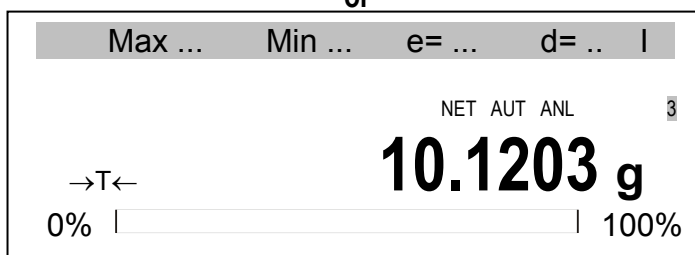

Press and hold  key

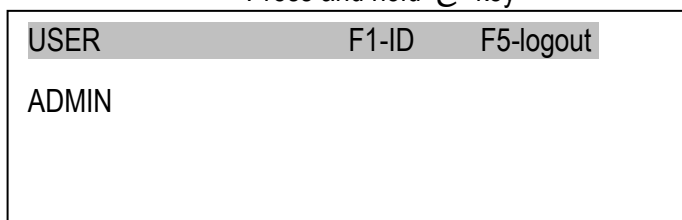

```

USER
ID:ADMIN
ADMIN
PIN:

```

After selecting ADMIN, PIN code must be entered.

ATTENTION:

User levels (privileges) start to work only if at least one user with level 3 privileges is created. If you create user with highest level of privileges (level 3) then only the user will be able to access all functions/options in balance. Remember to write down PIN code!

User database

```

USER
1. Log in ADMIN
2. Mode: <Standard><Limited>
3. Auto-Log out: <Off><5min.><15min.><30min.>
4. Mainscreen <On><Off>
5. Database
6. Shortcut: <-><F1><F2><F3><F4><F5>
7. USER\DATABASE
1. Edit
2. New
3. Delete one
4. USER EDIT
5.
6.
1. ID:
2. Name:
3. PIN:
4. Level: <1><2><3>
5. Save
6. Exit

```

Database enables to add (*New*), edit or delete users.

After selecting *New* or *Edit* user can inscribe user ID (max 8 signs), name (max 12 signs), PIN code (max 8 signs) and user *level* (user privileges). At the end select *Save*.

User levels (privileges) start to work only if at least one user with level 3 privileges is created.

User levels:

- „1” - viewing available menus,
- launching available active applications,
- changing parameters (available in applications) which are not saved in non-volatile memory,
- „2” - level „1” privileges,
- activating applications,
- changing app parameters which are saved in non-volatile memory,
- „3” - level „2” privileges,
- changing balance and user settings in „2.Configuration” menu.

Attention!

User levels (privileges) start to work only if at least one user with level 3 privileges is created. If you create user with highest level of privileges (level 3) then only the user will be able to access all functions/options in balance. Remember to write down PIN code!

15.2 Application selection – creating personalized menu

All balances besides basic metrological functions: weighing and tare, have many applications (functions) and configuration options.

SETUP
1. User
2. Menu
3. Calibration
4. Auto-zeroing
5. Unit
6. Interface
7. Print setup
8. LCD settings
9. Language
10. Time&date
11. Keyboard
12. Analog output
13. Speed
14. Firmware update

In order to limit user applications quantity that appear after pressing Menu key (and choosing *Applications* option), user can choose several applications and create his own menu.

Creating personalized menu:

During balance's first start, after pressing *MENU* key choose *Menu* option. List of applications will show up. Precise description of all applications in *Applications* chapter.

Adding applications to personalized menu is done by pressing *ENTER* key when chosen application is highlighted.

Added application is marked with „v” sign.

After choosing all necessary applications use *Exit* option.

MENU
<input type="checkbox"/> Product
<input type="checkbox"/> PCS
<input type="checkbox"/> Unit
<input type="checkbox"/> Percent
<input type="checkbox"/> (Label)
<input type="checkbox"/> Animal
<input type="checkbox"/> Tare setting
<input type="checkbox"/> MAX/MIN
<input type="checkbox"/> Newton
<input type="checkbox"/> Total
<input type="checkbox"/> Threshold
<input type="checkbox"/> Stats
<input type="checkbox"/> Paper
<input type="checkbox"/> Recipe
Exit

Defaults option deletes all applications from personalized menu (return to default settings).

15.3 Calibration with external weight / calibration options

Calibration with external weight should be performed if balance accuracy after internal calibration is not satisfactory (in case of ALN/G). Calibration weight stated in technical data table for the balance (or of better accuracy) with valid verification certificate should be used then.



Calibration of legally verified balance requires violating a mark used to protect an access to adjustment switch and results in losing legal verification. To renew legal verification of the balance, it is necessary to contact a service or notified body.

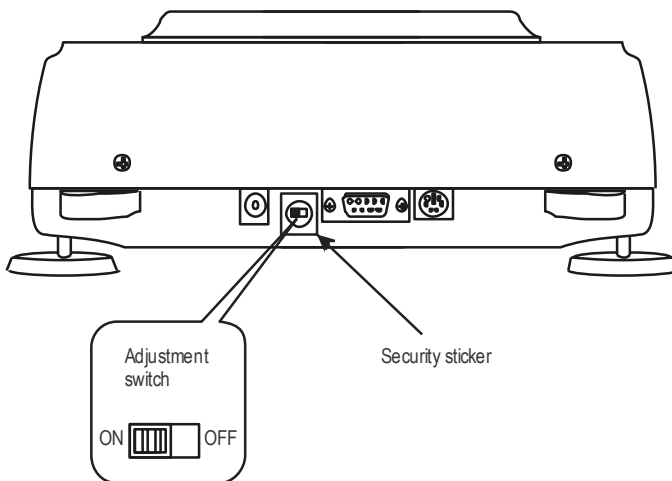

In balances comply with verification requirements performing calibration requires changing adjustment switch position, which is placed behind protecting mark (sticker) of a notified body. An access to the switch is possible only after removing the mark.

Before proceeding with calibration for balances comply with verification requirements, adjustment switch should be set to *ON* position using thin screwdriver (the balance will display the message *Pr ON*).

When calibration process, described on next page, is finished, the balance will display the message *Pr ON*. Adjustment switch should be set to *OFF* position using thin screwdriver (the balance will move to weighing).

In order to calibrate the balance use *MENU* key, choose *Setup* option and then *Calibration*.

SETUP
1. User
2. Menu
3. Calibration
4. Auto-zeroing
5. Unit
6. Interface
7. Print setup
8. LCD settings

CALIBRATION
1. Calibration:
2. Mode
3. Load: <...>
4. Report
5. Linearity
6. Exit

CALIBRATION
1. Calibration:
2. Mode
3. Load: 100g
4. Report
5. Linearity
6. Exit

Load option enables inscribing standard of mass value, which will be used to calibrate (it is suggested to use standard of mass value close to balance's max).

SETUP

1. User
2. Menu
3. Calibration
4. Auto-zeroing
5. Unit
6. Interface
7. Print setup
8. LCD settings
9. Language
10. Time&date
11. Keyboard
12. Analog output
13. Firmware update
14. Defaults

After setting standard of mass value, prepare standard of mass, choose *Calibration* option and press *ENTER* key.

CALIBRATION

1. Calibration:
2. Mode
3. Load: 100g
4. Report
5. Linearity
6. Exit

CALIBRATION

Please wait ...

CALIBRATION

Taring

CALIBRATION

Put load

Put standard of mass on pan.

CALIBRATION

Please wait ...

Max ... Min ... e= ... d= ..

100.0000 g

0% | _____ | 100%

Standard of mass value indication means that calibration process ended.



Besides *Report* option, all other calibration options are available after switch position change.

The form of ACA/G balance calibration report printout:

----- CALIBRATION REPORT -----

ACA220G MAX=220g e=0.01g d=0.001g
S/N : 1234
PROD.DATE: 2015-10-25
FIRM.VER.: ACAG01 2015-10-23 AD7710 SIL

FACTORY EXT.LOAD : 200.00 g
FACTORY INT.LOAD : 196.131 g
CALIBRATION NO. : 1
CALIBRATION DATE : 2015-01-22
CALIBRATION TEMP: 30.346 'C
CURRENT EXT.LOAD : 200.00 g
CURRENT INT.LOAD : 196.131 g
WEIGHT DIFFERENCE: 0.00 g

- external standard of mass used by producer
- internal standard of mass weight registered by producer

- external standard of mass used during last calibration
- internal standard of mass weight registered during last calibration
- difference between internal standard of mass: factory-actual

15.4 Auto-zeroing function

Auto-zeroing special function ensures that balance's indications close to zero will be corrected automatically and when the pan is unloaded zero indication will be maintained (regardless of environment conditions).

SETUP	
1. User	
2. Menu	
3. Calibration	
4. Auto-zeroing	
5. Unit	
6. Interface	
7. Print setup	
8. LCD settings	
9. Language	
10. Time&date	
11. Keyboard	
12. Analog output	
13. Firmware update	
AUTO-ZEROING	
1. Status:	OFF
2. Exit	
AUTO-ZEROING	
1. Status:	<ON> <OFF>
2. Exit	

To turn on the function use navigation keys and *ENTER* key, choose Status *ON*.

15.5 Unit selection

In order to change default unit type used in balance use *MENU*, choose option *Configuration* and *Units*.

SETUP

1. User
2. Menu
3. Calibration
4. Auto-zeroing
5. Unit
6. Interface

UNIT

- Miligram [mg]
- Gram [g]
- Kilogram [kg]
- Carat [ct]
- Pound [lb]
- Ounce [oz]
- Ounce troy [ozt]
- Grain [gr]
- Pennyweight [dwt]
- Exit

Selection of units:

- Carat (1 ct= 0,2 g),
- Miligram (1mg=0,001g),
- Kilogram (1kg=1000g),
- Pound (1 lb=453,592374g),
- Ounce (1oz=28,349523g),
- Ounce troy (1ozt=31,1034763g) pharmaceutical ounce,
- Grain (1gr=0,06479891g) - grain
- Pennyweight (1dwt=1,55517384g) jewellery mass unit,
- Gram (1g) - gram.

Readout for different units:

Unit	Readout unit	
	ACA220G÷ACA1020G ACZ220G÷ACZ1020G	ACA2200G÷ACA6200G ACZ2200G÷ACZ6200G
g	0,001 g	0,01 g
ct	0,005 ct	0,05 ct
lb	0,000 005 lb	0,000 05 lb
oz	0,000 05 oz	0,000 5 oz
ozt	0,000 05 ozt	0,000 5 ozt
gr	0,02 gr	0,2 gr
dwt	0,001 dwt	0,01 dwt

Unit selection is done with navigation keys and ENTER key.

15.6 Interface parameters setting



SETUP

1. User
2. Menu
3. Calibration
4. Auto-zeroing
5. Unit
6. Interface
7. Print setup
8. LCD settings
9. Language
10. Time&date
11. Keyboard
12. Analog output
13. Firmware update
14. Defaults

INTERFACE

1. Port 1
2. Port 2
3. USB host*
4. Exit

The function allows setting independently communication parameters of serial ports *Port-1* and *Port-2* (executed in RS232C, RS485, USB or LAN standard):

- transfer protocol (*Prot*):
LonG – cooperation with printer or computer,
EPL – cooperation with label printer in normal mode (activates *LAbEL* function),
EPL_A – cooperation with label printer in automatic mode (activates *LAbEL* function),
EPL_d – cooperation with special label printers,
Pen-01 – cooperation with pendrive or PEN-01,
 - baud rate (*bAud*): (4800, 9600,115 200bps),
 - number of bits in single char. (*bitS*): 7, 8,
 - parity control (*PARtY*):
nonE – no control
Odd –nonparity
Even – parity control,
 - scale number in network (*nr*):
(if the scale doesn't work in network the number must be 0),
 - transmission through serial interface (*SendInG*):
StAb – transmission after  key is used and result is stable,
noStAb – transmission after  key is pressed without need of stabilisation,
Auto - automatic transmission after load is put on and result is stable (*Auto*),
Cont - continuous transmission, about 10 results per second (*Cont.*),
Remove - trans
- Default parameter values:
Long, 9600 bps, 8 bits, none, StAb,
- *SCAnn* – cooperation with MJ-4209 barcode readers.

In order to set needed parameters choose *Interface* function, select appropriate parameter and press $\rightarrow T \leftarrow$ key when required option or parameter value is displayed.

In scales with an additional serial port *Port-1* and *Port-2* appears for the independent setting of both ports.

*Only in scales equipped with USB_A. User can select protocol type and sending method (if needed).

15.7 Print setup

SETUP

1. User
2. Menu
3. Calibration
4. Auto-zeroing
5. Unit
6. Interface
7. Printout
8. LCD settings
9. Language
10. Time&date
11. Keyboard
12. Analog output
13. Firmware update
14. Defaults

PRINT SETUP

1. Port 1 (RS-232C)
2. Port 2 (USB)
3. USB Host*
4. Meas. number reset
5. Meas. number save <Off><On>

PRINT SETUP\PORT 1

- Auto-header
- Header
- Values
- Footer
- Field 1
- Field 2
- Field 3

Function is used for printing additional information stored in scale memory, weighed product identification data and scale operator id. That information is inscribed using scale keys or scanner.

After selecting *Printout* option user can choose (attention: number of ports can differ):

- *Port 1 (RS232C)* – printout configuration for RS232C,
- *Port 2 (USB)* – USB print configuration,
- *USB host* – USB host print configuration,
- *Meas. number reset* resets actual print (meas.) number.
- *Meas. number save* turns on saving the printout number after switching off the balance.

After selecting one of the interfaces user can choose:

- *Auto-header* – automatic printout of header when measurement number is 0,
- *Header* – selection of fields printed in header,
- *Values* – selection of fields printed between header and footer,
- *Footer* – selection of fields printed in footer,
- *Field 1* -
- *User ID* – scale user identification number,
- *USER nA* – user name,
- *Prn no* – successive printout number,
- *Prod Id* – product number,
- *Prod bA* – product barcode (inscribed or scanned),
- *Prod nA* – product name,
- *Count* – counting result (PCS function),
- *APW* – unitary mass (PCS function),
- *nEt* – net mass
- *tArE* – current tare value,
- *GroSS* – gross mass,
- *totAL* – total mass (*totAL* function)

If the scale is equipped with two serial joints *Print* function is set independently for both interfaces (Port 1 and Port 2).

Sample printout during normal weighing (all printout positions deactivated):

```
20.07 kg
20.04 kg
20.04 kg
```

Sample printout during normal weighing with clock option (all printout positions deactivated):

```
20.07 kg 2012-11-08 10:01
20.04 kg 2012-11-08 10:01
20.04 kg 2012-11-08 10:01
```

Sample printout during normal weighing (some printout positions activated):

```
ALN220G MAX=220g e=0.001g d=0.0001g
S/N : 30000017

USER ID. : 000001
DATE : 2012-11-08
TIME : 12:26
NO : 3
PROD ID : 01
COUNT : 0 PCS
APW : 0.0000 g
NET : 213.8 g
TARE : 0.0000 g
GROSS : 213.8 g
TOTAL : 0.0000 g
```

15.8 LCD settings

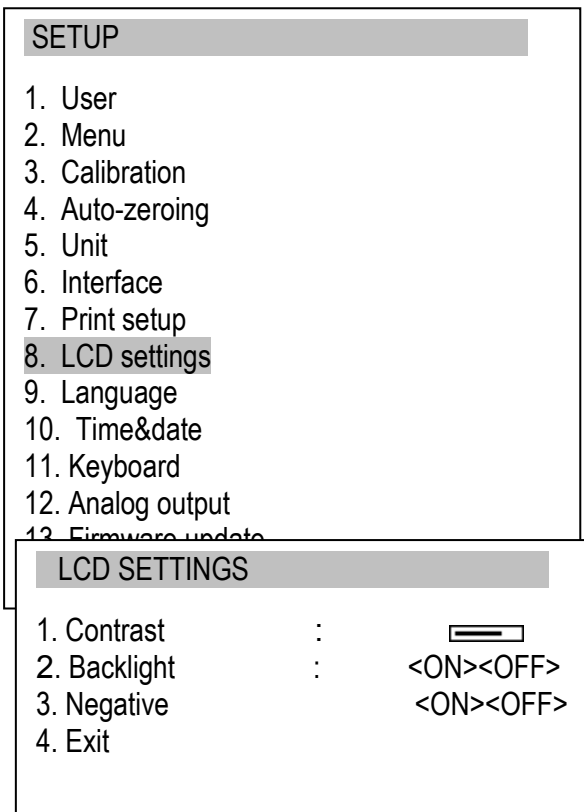

LCD settings enable to set contrast and backlight.

Function has below options:

- *Contrast* - setting LCD contrast,
- *Backlight* – backlight brightness,
- *Negative* – black background with bright letters on display.

15.9 Language selection

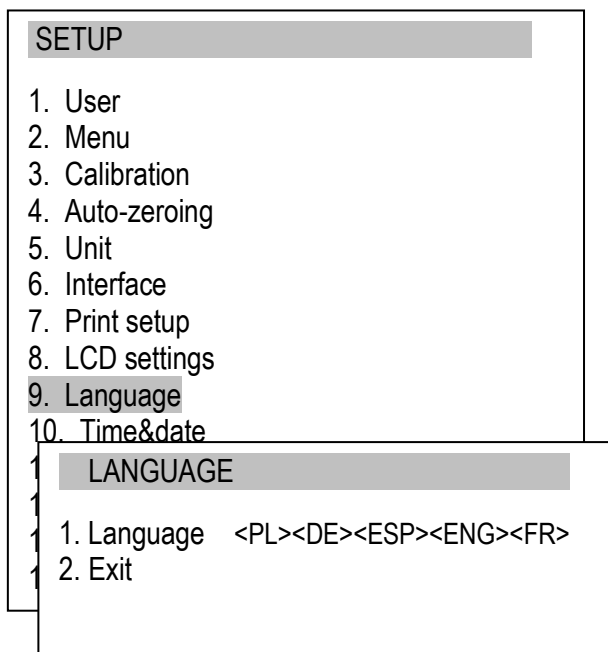

Function enables to set language:

- Polish
- German
- Spanish
- French
- Italian
- Czech
- Russian
- Ukrainian
- English

Language selection may vary depending on your region.

15.10 Setting date and time

SETUP

1. User
2. Menu
3. Calibration
4. Auto-zeroing
5. Unit
6. Interface
7. Print setup
8. LCD settings
9. Language
10. Time&date

TIME&DATE

1. Time: 09:11:03
2. Date: 2015-10-01
3. PIN ...
4. 12/24: <12H><24H>
5. Form.: <YYYY-MM-DD><MM-DD-YYYY><DD-MM-YYYY>
6. Main screen <on><off>
7. Exit

Function enables setting actual time and date and displaying format.

Options description:

PIN – after inscribing PIN code (4 digits) changing time or date won't be possible without PIN code.

Main screen – after turning on the date and time will be shown on main screen.

15.11 Keyboard options

SETUP

1. User
2. Menu
3. Calibration
4. Auto-zeroing
5. Unit
6. Interface
7. Print setup
8. LCD settings
9. Language
10. Time&date
11. Keyboard
12. Analog output
13. Firmware update

KEYBOARD

1. Sound <on><off>
2. Mode <1><2>
3. PS/2 <on><off>
4. Exit

Function enables to set options related to scale's keyboard: sound when pressing keys, PS/2 interface activity and keyboard working mode.

1 mode: keys 0-9 alphanumeric,
2 mode: keys 0-9 inscribe only numbers or letters; switchable using ● key.

15.12 Analog output

SETUP	
1. Menu	
2. Calibration	
3. Auto-zeroing	
4. Unit	
5. Interface	
6. Print setup	
7. LCD settings	
8. Language	
9. Time&date	
10. Keyboard	
11. Analog output	
12. Firmware update	

ANALOG OUTPUT	
1. Range:	<...>
2. Mode:	<-><+/-><+>
3. Exceed:	<Zero><Max
4. Exit	

Function enables to set options regarding analog out:

- Range – weight value when the analog out has max value,
- Mode – falling characteristic, falling-rising characteristic, rising,
- Exceed – analog out state when the balance's range is exceeded (H or L indication).

15.13 Speed

SETUP	
1. Menu	
2. Calibration	
3. Auto-zeroing	
4. Unit	
5. Interface	
6. Print setup	
7. LCD settings	
8. Language	
9. Time&date	
10. Keyboard	
11. Analog output	
12. Speed	
13. Firmware update	
13. Defaults	

SPEED	
<input type="checkbox"/> Default	
<input type="checkbox"/> Slow	
<input type="checkbox"/> Medium	
<input type="checkbox"/> Fast	
Exit	

Option enables to change weighing speed, that enables better performance thanks to adaptation to environment conditions.

Options:

- Default – default weighing speed,
- Slow – slow speed/measurement,
- Medium – medium speed/measurement,
- Fast - fast speed/measurement.

Attention:

When setting Fast option check if weighing results are stable. If not, use slower option

16. Applications

The balance enables to use many applications (special functions). Before using them user must create personalized menu, where he puts chosen applications (chapter 15.1).

MENU
1. Applications
2. Setup
3. Info
4. Exit
APPLICATIONS
<input type="checkbox"/> Product
<input type="checkbox"/> PCS
...
Exit

In order to use applications press *MENU* key:

- *Applications* – personalized menu,
- *Setup* – creating personalized menu, calibration, balance options,
- *Info* – information about the balance,
- *Exit*.

Move cursor to *Applications* and press *ENTER*.

Personalized user menu will show up, which consists chosen previously applications (look *Configuration/Menu*).

Actually active applications are marked with sign. It is possible to activate a few applications at one time (if they don't conflict).

List of available applications:

- Product ID – assigning identification number to product
- PCS – pieces counting
- Unit – actual weight unit selection
- Percent – percentage conversion
- LabEL* - label number selection
- Animal – animal weighing
- Tare setting – storing tare value
- MAX/MIN – maximal value indication
- Newton – indication in force units
- Total – summing series of weighing
- Threshold – comparing with thresholds
- Stats – statistics calculations
- Paper – paper grammage counting
- Recipe – recipe making

Some functions need additional equipment to be visible and/or completely functional:

- *Date&time* and *Total* need clock to be installed in balance,
- Comparing with thresholds function has full functionality when threshold (WY[⌈]⌋) out is installed in scale.

**Label* function is used in scales with *EPL* or *EPL-A* transmission protocol set (look *Configuration*)

16.1 Product database

The product database enables to add, edit, delete and select product. Enter *Applications* and select *Product* (remember to activate Product function before to use it). You will see below options:

APPLICATIONS

Product

PCS

...

PRODUCT

1. Product:

2. Mode: <Standard><Limited>

3. Autoreset: <Off><On>

4. Mainscreen: <Off><On>

5. Database

6. Shortcut: <F1><F2><F3><F4><F5>

PRODUCT	F1-ID	F5-unselect
Apples		
Bananas		

- *Product* – opens list of products,
- *Mode* – changing products database working mode:
Standard – work with products from and outside database,
Limited – work with products only from database,
- *Autoreset* – after each measurement printout (or sending to computer) deselecting product,
- *Mainscreen* – product name on main weighing screen,
- *Database* – adding, editing, printing and erasing products,
- *Shortcut** – set fast access key for login user (if you have USB_A interface and PC keyboard connected).

After selecting *Product* user can select product from list using navigation keys and Enter or press F1 to inscribe ID number of desirable product.

*REMEMBER:

If you want to get fast access to products list then set shortcut for it. For example if you set F2 shortcut then from the main weighing screen you press only F2 and have the products list on display.

PRODUCT

1. Product:

2. Mode: <Standard><Limited>

3. Autoreset: <Off><On>

4. Mainscreen: <Off><On>

5. Database

6. Shortcut: <F1><F2><F3><F4><F5>

PRODUCT/DATABASE

1. Edit

2. New

3. Delete one

4. Delete all

5. Printout

6. Exit

Database options:

- *Edit* – changing product data,
- *New* – adding new product,
- *Delete one* – deleting one product,
- *Delete all* – delete all products,
- *Printout* – print list of products.

PRODUCT EDIT	
1. ID:	
2. Barcode:	
3. Name:	
4. Label No:	
5. Tare	
6. MIN tresh.:	
7. MAX tresh.:	
8. Application	<-><PCS><PRC>
9. Parameter 1:	
10. Parameter 2:	
11. Parameter 3:	
12. Parameter 4:	
13. Save	
14. Edit	

If you select *Edit* or *New* you will see below options:

- *ID* – inscribing product identification number (max 8 signs),
- *Barcode* – inscribing product barcode (max 16 signs),
- *Name* – inscribing product name (max 20 signs),
- *Label No* – set corresponding label number if you use label printer,
- *Tare* – product tare value,
- *MIN tresh.* – minimal product weight threshold value,
- *MAX tresh.* – maximal product weight threshold value,
- *Application* – use if you want automatically turn on PCS or Percentage application when you select the product.

Parameters 1-2 can be used when you set *Application* option:

	PCS	PRC
Parameter 1	unitary weight	100% weight
Parameter 2	no. of pieces	-
Parameter 3	-	-
Parameter 4	-	-

Parameters 2-4 are not active in analytical balances.

REMEMBER:

After you inscribe all the product data remember at the end to select Save.

Using barcode reader is beneficial when user want to select products from big database immediately.

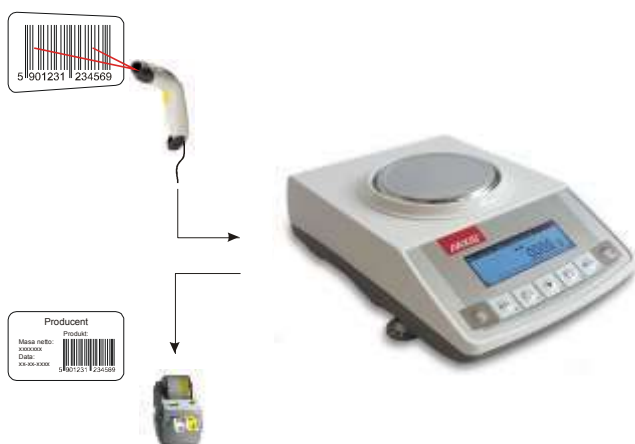

After selecting product it is possible to send (to computer or printer) actual indication with additional data, selected by *Print setup* option.

The measurements are also stored in balance internal memory if balance is equipped with ALIBI memory.

16.2 Pieces counting

The application enables to count identical pieces, e.g. turnbuckles or buttons in weighed portion basing on calculated single unit weight in a sample. It is suggested that the single unit weight (APW) is bigger than balance's readout value and sample weight is bigger than 100 readout units.

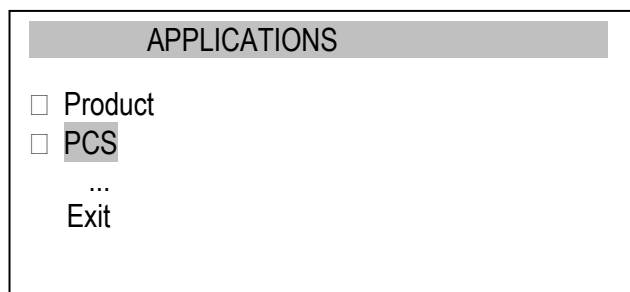

Application options:

- *Activation* – Activate pieces counting for actual weight and below settings,
- *Sample size* – pieces quantity in sample,
- *APW* – set unitary mass directly,
- *Shortcut* - set fast access key for login user (if you have USB_A interface and PC keyboard connected).

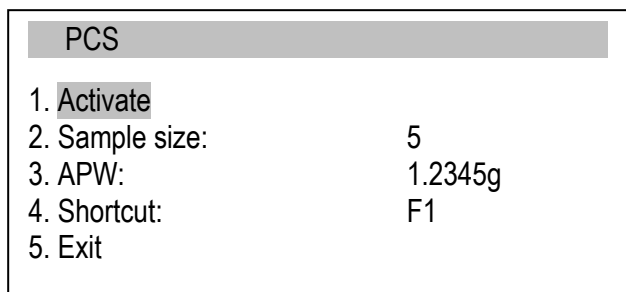

Measurement consists of 3 phases:

- Taring empty container (or empty pan)
- Single unit mass counting
- Counting pieces quantity in weighed portion

Actions order:



Put empty container on pan and press →T← key.

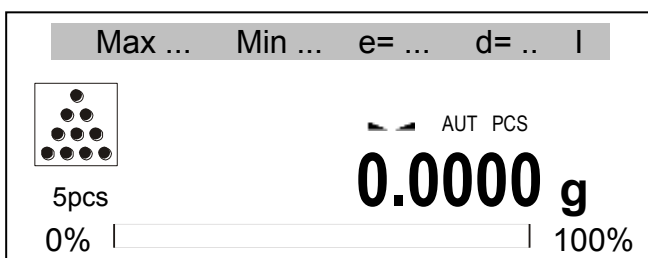

Wait until indication is zero

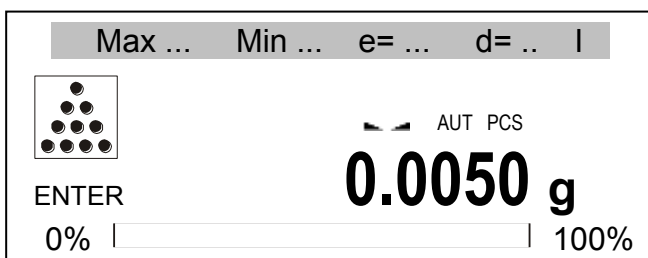

Put on a sample with pieces quantity earlier inscribed and press *ENTER*,

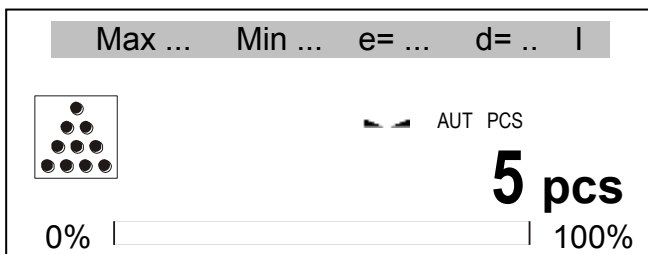

Balance shows pieces quantity. Put on portion of pieces.

To end working with the function press *MENU*, choose *Applications*, then *PCS* and *Deactivation*.

Note:

APW too LOW communicate signalises that a sample was not put on the pan or if single piece weight is less than one-tenth readout plot (counting is not possible).

APW LOW communicate signalizes that single piece weight is more than one-tenth but less than one readout plot. (counting possible but with bigger errors, result blinks).

16.3 Unit

Unit application enables to choose actually used mass unit.

Chosen unit changes to default after balance turns off.

APPLICATIONS

Product

PCS

Unit

...

Exit

UNIT

Miligram [mg]

Gram [g]

Kilogram [kg]

Carat [ct]

Pound [lb]

Ounce [oz]

Ounce troy [ozt]

Grain [gr]

Pennyweight [dwt]

Exit

Selection of units:

- Carat (1 ct= 0,2 g),
- Miligram (1mg=0,001g),
- Kilogram (1kg=1000g),
- Pound (1 lb=453,592374g),
- Ounce (1oz=28,349523g),
- Ounce troy (1ozt=31,1034763g) pharmaceutical ounce,
- Grain (1gr=0,06479891g) - grain
- Pennweight (1dwt=1,55517384g) jewellery mass unit,
- Gram (1g) - gram.

Readout for different units:

Unit	Readout unit	
	ACA220G÷ACA1020G ACZ220G÷ACZ1020G	ACA2200G÷ACA6200G ACZ2200G÷ACZ6200G
g	0,001 g	0,01 g
ct	0,005 ct	0,05 ct
lb	0,000 005 lb	0,000 05 lb
oz	0,000 05 oz	0,000 5 oz
ozt	0,000 05 ozt	0,000 5 ozt
gr	0,02 gr	0,2 gr
dwt	0,001 dwt	0,01 dwt

Unit selection is done with navigation keys and ENTER key.

16.4 Percentage

Percent application allows displaying weighing result in percents.

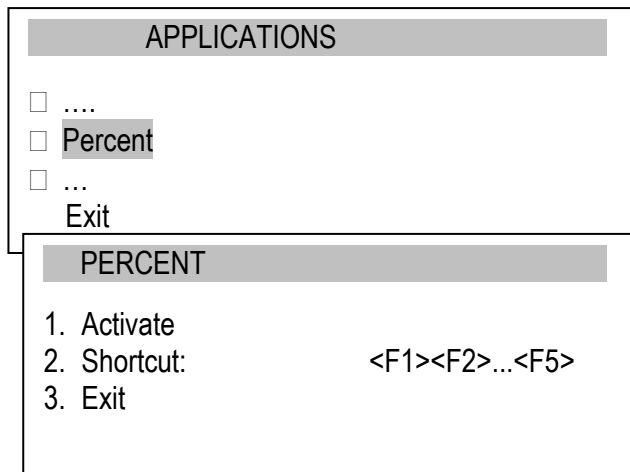

Applications options:

- *Activate* – inscribing actual indication as 100%, conversion to % indications,
- *Shortcut* - set fast access key for login user (if you have USB_A interface and PC keyboard connected).

A measurement is performed in two phases:

- first phase – weighing a reference sample (100%),
- second phase – measuring specific sample as a percentage of the reference sample.



Actions order:

Put empty container and press →T←.



Wait until balance indication zeroing.



Put reference sample (100%) and press **ENTER**,

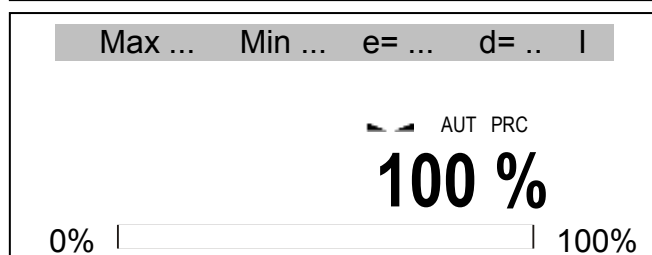

Balance shows in percentage.

In order to end working with function press **MENU** key, choose *Percent* and *Deactivate*.

16.5 Animals weighing

The application allows weighing animal moving on the scale.

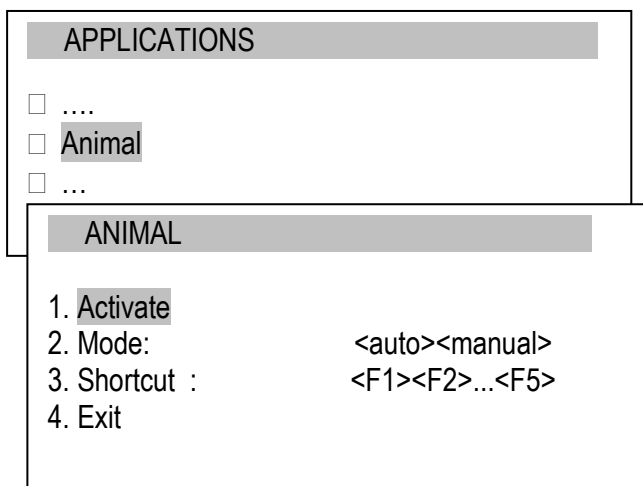

Application options:

- Activate – animals weighing activation,
- Mode:
 - <auto> - automatic weighing after weight load change,
 - <manual> - after putting animal and pressing *ENTER*,
- Shortcut - set fast access key for login user (if you have USB_A interface and PC keyboard connected).



Actions order:

Put empty box and press →T←.



Wait until balance indication zeroing.



Put animal in box and press *ENTER*.



The balance makes a series of measurements and displays result. After unloading the balance is ready for next measurement.

The balance will show stable (averaged) result and will send it through serial port.

To end working with the function press *MENU* key, choose *Animal* and *Deactivation*.

16.6 Tare setting

This app enables to measure gross weight of a sample placed in a container of a known weight value (stored in the memory) and to display calculated net weight of the sample. Tare value is recalled from the memory with $\rightarrow T \leftarrow$ key when the pan is empty. Tare value may be entered using keypad or by putting container on the pan.

APPLICATIONS	
<input type="checkbox"/>
<input type="checkbox"/>	Tare setting
<input type="checkbox"/>	...
Exit	

TARE SETTING	
1.	Activation
2.	Tare from scale
3.	Tare value: 1.2345g
4.	Shortcut: F2
5.	Exit

Application options:

- *Activation* – activate tare,
- *Tare from scale* – inscribing actual indication as tare,
- *Tare value* – value inscribed by keys,
- *Shortcut* - set fast access key for login user (if you have USB_A interface and PC keyboard connected).

Max ...	Min ...	e= ...	d= ..	l
AUT				
10.0004 g				
0%				100%

Actions order:

Put an object on pan and press shortcut key (chosen earlier) to *Tare setting* application eg. F2.

TARE SETTING	
1.	Activation
2.	Tare from scale
3.	Tare value: 1.2345g
4.	Shortcut: F2
5.	Exit

Application options show up. Choose *Tare from scale* or *Tare value* (inscribe value and press *ENTER*) and next *Activation*.

Max ...	Min ...	e= ...	d= ..	l
NET AUT				
0.0000 g				
0%				100%

The balances shows indications with tare.

Max ...	Min ...	e= ...	d= ..	l
NET AUT				
- 10.0004 g				
0%				100%

After pressing $\rightarrow T \leftarrow$ or unloading pan the balance will show minus indications (tare value subtraction). In order to end working with application press *MENU*, choose *Tare setting* and *Deactivation*.

16.7 Max or minimum value indication

Application enables to freeze on display maximal or minimal value.

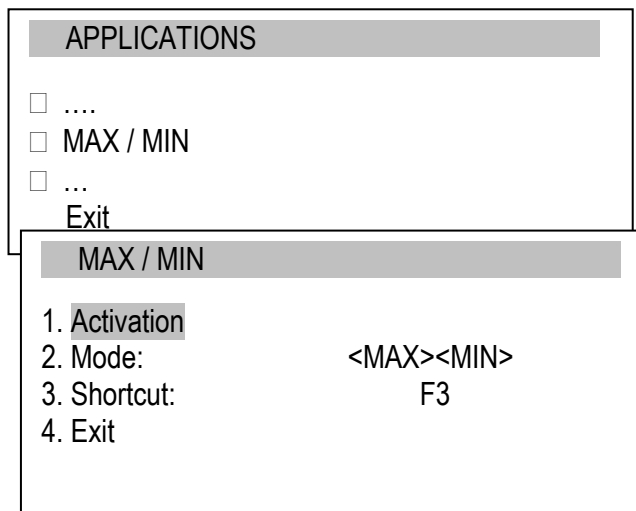

Application options:

- *Activation* – move to weighing with MAX/MIN value indication,
- *Mode* – maximal value (MAX) or minimal (MIN),
- *Shortcut* - set fast access key for login user (if you have USB_A interface and PC keyboard connected).



Order of actions:

Perform series of weighing. The balance indicates the max (or min) weight value.



→T← key causes balance zeroing and enables to start next series of weighing.

In order to finish working with the app press *MENU* key, choose *MAX/MIN* and *Deactivation*.

16.8 Force indication (Newton)

The application enables to measure balance's pan load force.

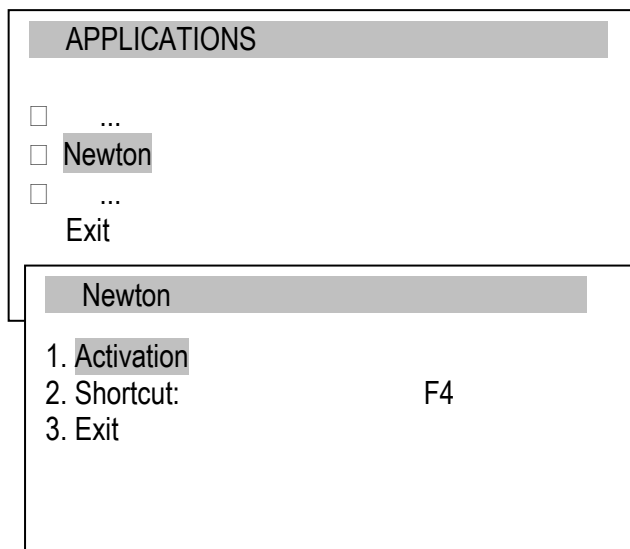

Application options:

- Activation – force measurement start,
- Shortcut - - fast access key selection: F1, F2,... or F5.



Order of actions:

After activation the application is ready to work. Exert force on pan (do not overload the pan!) and the balance will show result in N unit.

In order to finish working with the app press *MENU* key, choose *Newton* and *Deactivation*.

16.9 Total

Application enables to sum up successive measurements and calculate average value.

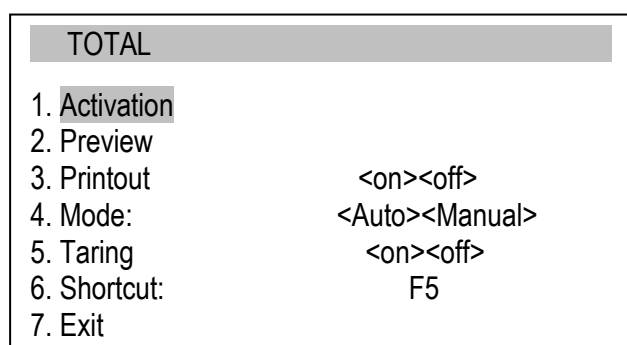
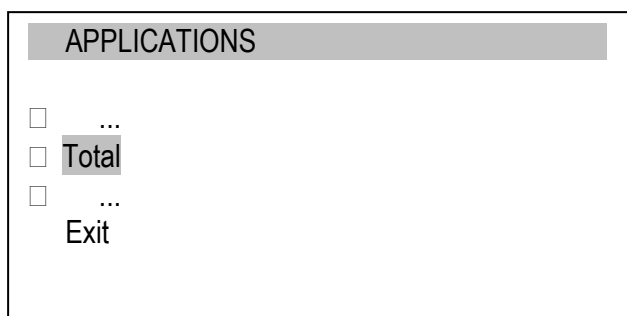

Application options:

- *Activation* – start Total app,
- *Preview* – summing register check,
- *Printout* – printout on/off
- *Mode* – adding result:
 - <Auto> - when indication is stable,
 - <Manual> - after putting weight and pressing  key,
- *Taring* – summing with tare after each measurement (without unloading the balance),
- *Shortcut* - set fast access key for login user (if you have USB_A interface and PC keyboard connected).

Order of actions:

Make series of weighings, in *Manual* mode press  key after each measurement. In *Auto* mode measurement are stored automatically.

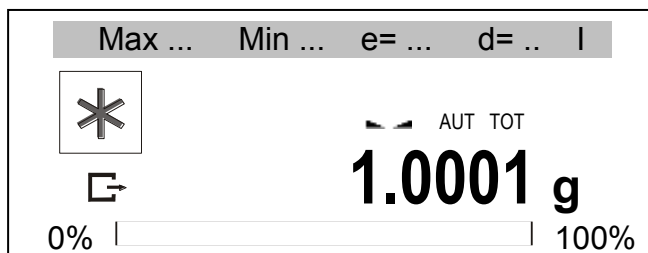

Each measurement inscribing is confirmed by displaying sum and average value.

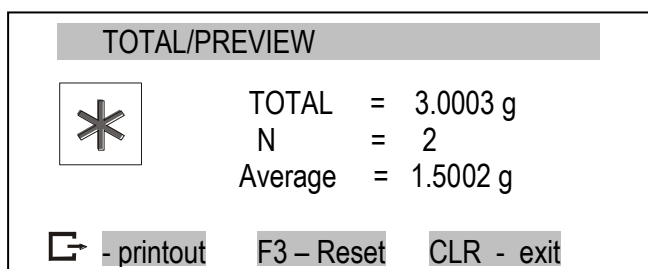

Another recalling the application and option *Preview* (or shortcut key use) displays sum, measurements quantity, average value and available options:

-  - register printout,
- F3 – reset (zeroing) memory
- CLR - back to summing

In order to end Total app choose the application, choose *Total* and *Deactivation*.

16.10 Checkweighing function (thr)

This app allows comparing weighing result with two programmed reference values: lower and upper threshold. Comparison result is signalled with indicators (MIN, OK, MAX) and sound signal generated (in *Impulse mode*) when threshold values are exceeded.

-

Standard scale is set for cooperation with optical indicator.

On outputs P1-P3 (*Relays socket*) short-circuit states appear as result of comparison scale indication with threshold values.

On the chart below output states are shown during increasing load on the scale for both working modes:

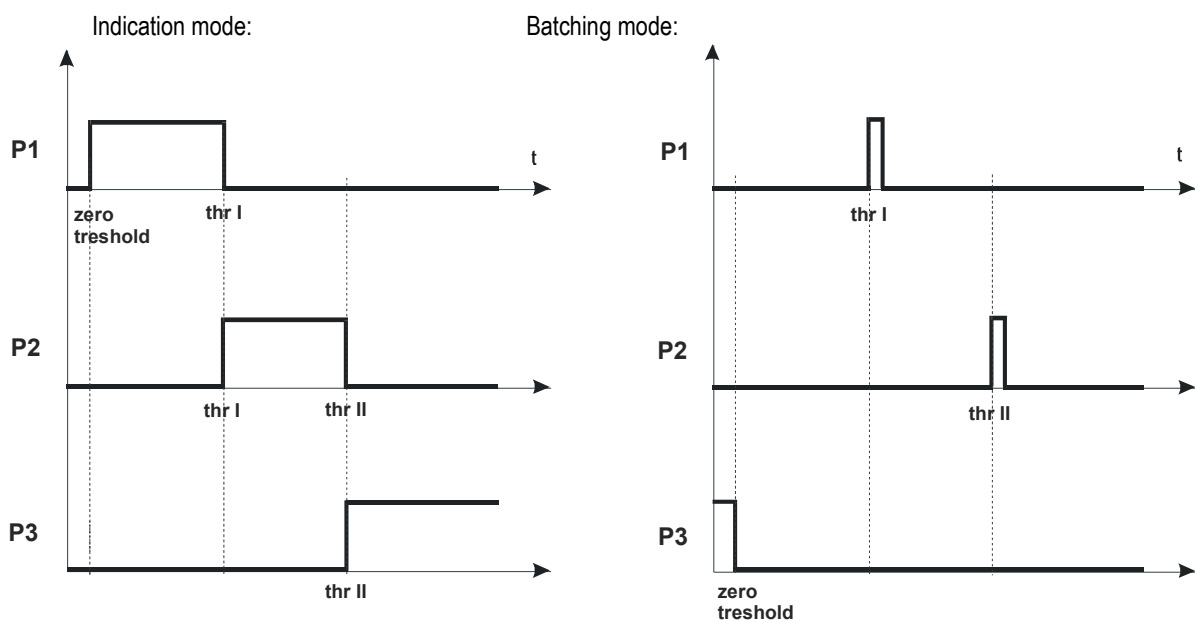

In *Batching* mode on P1 (thr I) and P2 (thr II) outputs short-circuit impulses appears for time of 0,5s. On P3 (zero) output short-circuit state appears when indication does not exceed threshold value signalling zero load.

Operation sequence:

APPLICATIONS

...

Threshold

...

Exit

THRESHOLD

1. **Activation**

2. Zero threshold 0.0010 g

3. MIN threshold 1.0000 g

4. MAX threshold 10.0000 g

5. Mode: <signaller><impulse>

6. Printout

7. Shortcut: F5

8. Exit

Application options:

- *Activation* – move to weighing with summing,
- *Zero threshold* – zero signalling threshold,
- *MIN threshold* – Minimum threshold signalling,
- *MAX threshold* – Maximum threshold signalling,
- *Mode* – working mode:
 - <signaller> indication mode (chart on previous site),
 - <impulse> impulses and sound signal (batching mode chart on previous site),
- *Printout* – threshold printout,
- *Shortcut* - set fast access key for login user (if you have USB_A interface and PC keyboard connected)..



Actions order:

- No load (load smaller than zero threshold)
- no signalization
- Put weight.

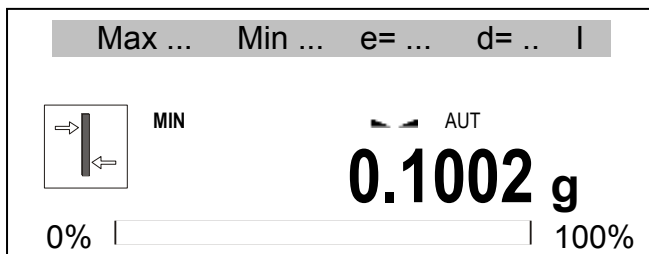

Case 1:

- Load under *MIN* threshold.
- balance signalizes to small value – *MIN*.

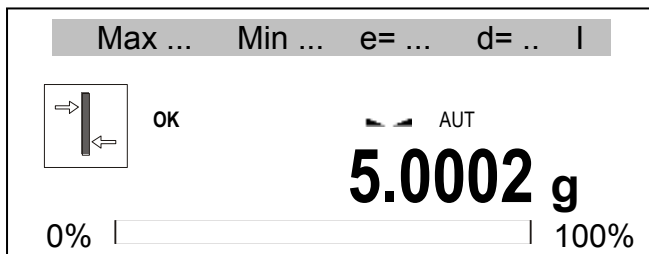

Case 2:

- Load above *MIN* threshold but under *MAX*
- balance signalizes good value – OK (in *Impulse* mode additional short sound signal occurs)



Case 3:

- Load above *MAX*.
- balance signalizes too big value – *MAX* (in *Impulse* mode additional long sound signal occurs).

Relays WY1 connection diagram:

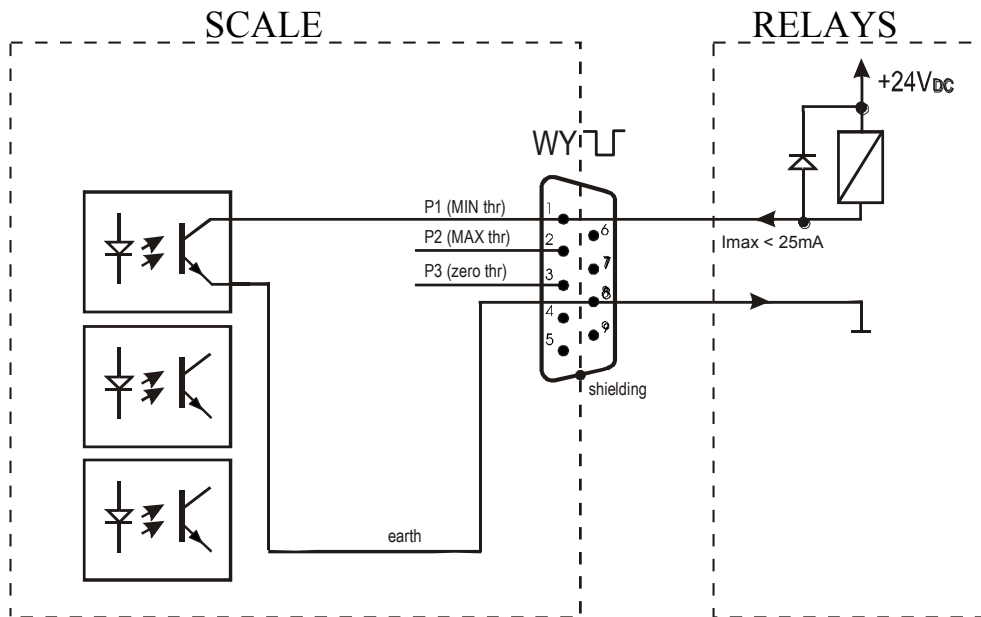

Relays output is the open collector transistor output with load capacity 25mA / 24V. Transmitter inputs must be protected with diodes, e.g. 1N4148.

It is advised to use MS3K/P electronic board (sold separately), consisting of RM96P transmitters, with DC24V input voltage and AC250V, 3A output.

Important notes:

1. After switching the scale on, both thresholds are set to maximum values.
2. When setting upper threshold value, pay attention that its value is not below lower threshold value.
3. Setting lower and upper threshold value is possible after sending appropriate orders from computer, what is described in scale user manual.

16.11 Stats

This function evaluates from series of measurements (max 1000) statistical parameters of weighting process.

Adding successively measurements to register is automatic and it occur after the scale is loaded and its indications stabilize.

After each loading printout is made with: number of measurements, result, date and time (if clock is installed and the function is activated).

For the obtained measurements series the scale evaluates:

- n -number of samples
- sum x -sum of all samples $sum_x = \sum x_n$
- \bar{x} -average value (sum x)/n
- min -minimal value from n samples
- max -maximal value from n samples
- max-min -maximal value minus minima value

- S -standard deviation $S = \sqrt{\frac{1}{(n-1)} \sum_n (x_n - \bar{x})^2}$
- srel -variance factor $srel = \frac{S}{x}$

Statistical calculations results can be printed.

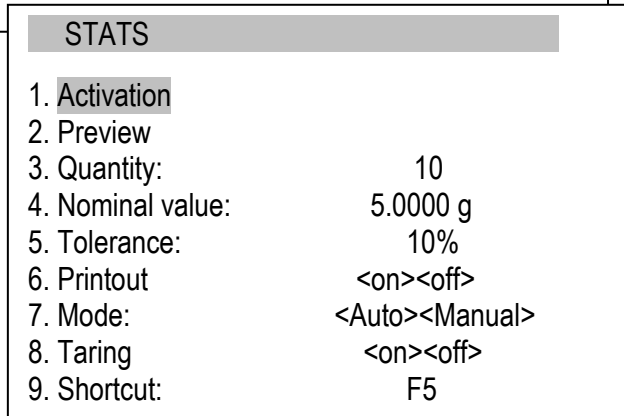
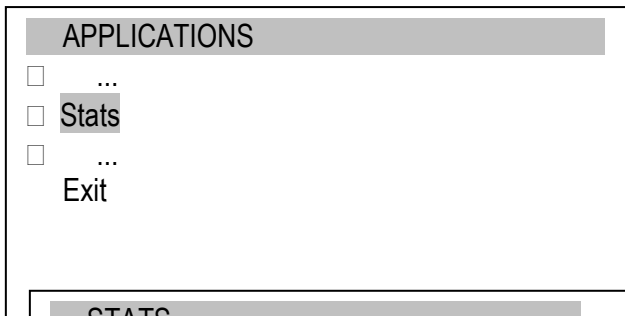

Applications option:

- *Activation* – move to weighing with summing,
- *Preview* – checking summing register state,
- *Mode* – add next result,
- <Auto> - automatic after stabilization,
- <Manual> - after putting load and pressing  key,
- *Taring* – summing with taring after each weighing (without putting off the weight from pan),
- *Shortcut* - set fast access key for login user (if you have USB_A interface and PC keyboard connected).

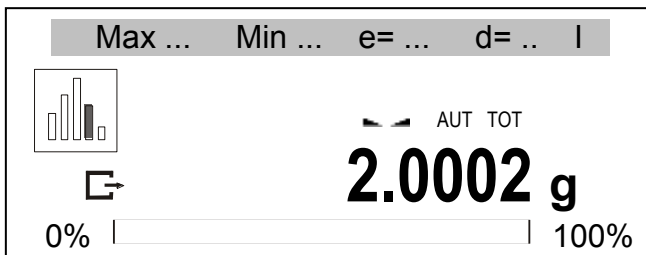

Actions order:

Make a series of measurements using  after each measurement. In *Auto* mode measurements are saved automatically.

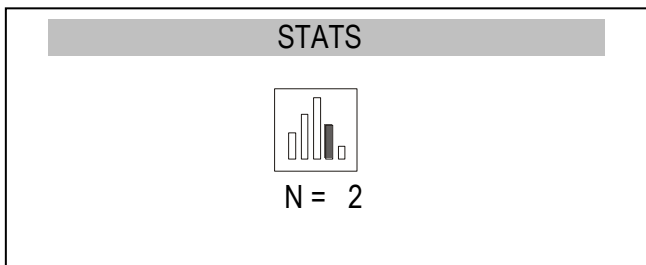

Each measurement inscribing is confirmed by displaying sum and average value.

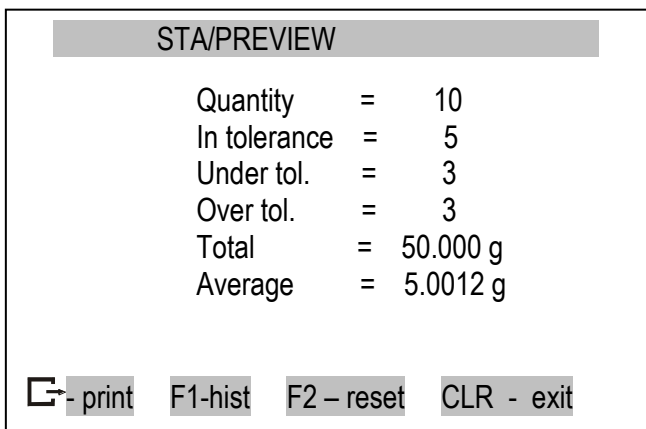

Choosing app and *Preview* option (or using shortcut key) displays statistical results and available options:

-  - stats register printout,
- F1 – displaying histogram,
- F2 – reset (zeroing) memory ,
- CLR - back to summing.

In order to end Stats app choose the application, choose *Total* and *Deactivation*.

Pressing  key printouts estimated values and histogram :

Nominal - nominal value,

Tolerance - accepted value in percentage.

N - number of sample

IN TOL. – number of samples in toleranc

-TOL – amount of measurements

under allowable lower value

+TOL – amount of measurements above

allowable upper value

TOTAL - sum of weights of all n samples

AVERAGE – average weight as (Total)/n

MIN – minimum weight in n samples

MAX– maximum weight in n samples

ST. DEV. – standard deviation

ST. DEV.% – standard deviation percentage

Statistics function cooperation with computer and

Printer. Scale can be equipped with two serial ports

marked as Port 1 (computer) and Port 2

(printer). After each data printout by printer identical

set of data is sent to computer. After sending by

computer initialization signal S A CR LF

(53h 49h 0Dh 0Ah) the scale sends to computer

statistic data enclosed in histogram.

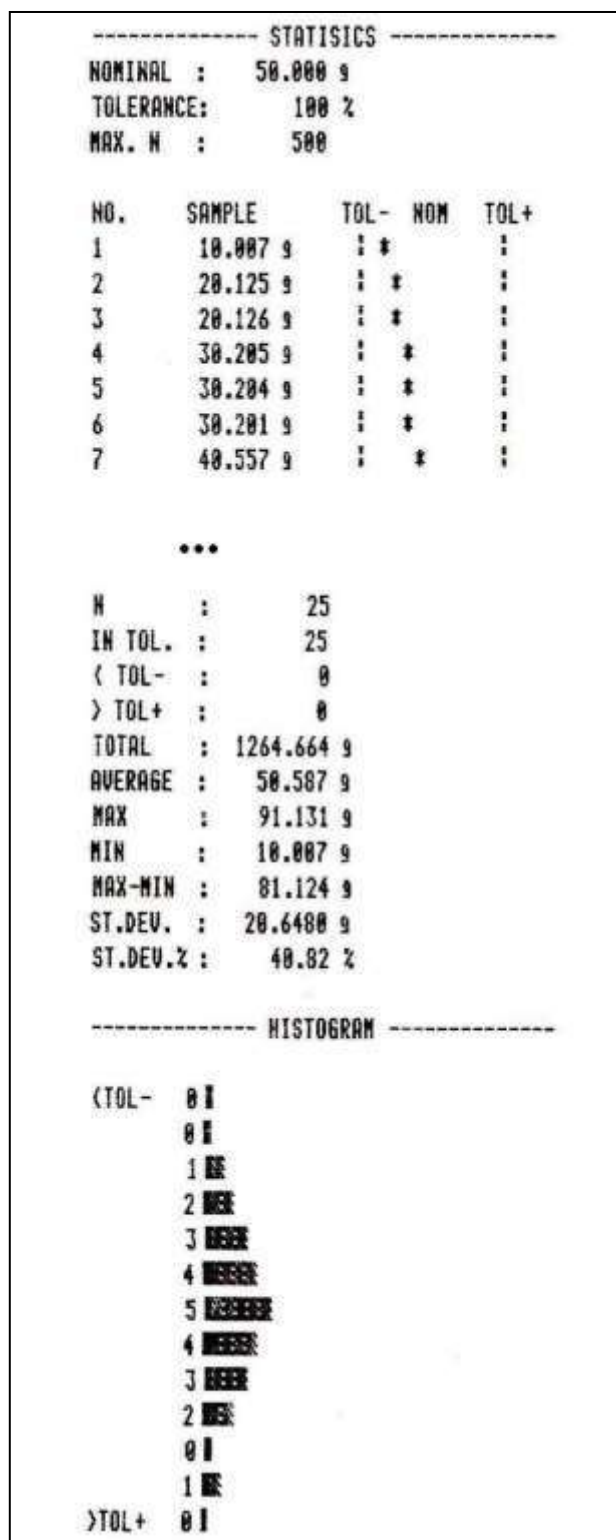

16.12 Paper grammage calculation (option)

The application enables to calculate paperweight (grammage) of 1m² paper basing on a sample of known area.

APPLICATIONS

...
 Paper
 ...
 Wyjście

PAPER

1. **Activate**
2. Quantity:
3. Area:
4. Shortcut: <-><F1><F2>...<F5>
5. Exit

Max ... Min ... e= ... d= .. II



AUT PAP

60.002 g/m²

0%100%

Application options:

- *Activation* – grammage calculation,
- *Quantity* – sheet of paper quantity,
- *Area* – sheet of paper are [in m2],
- *Shortcut* – set fast access key for login user (if you have USB_A interface and PC keyboard connected).

Actions order:

After inscribing sheets of paper quantity and their area use *Activation* option.

Paper grammage will be displayed (calculated as weight divided by area on one sheet of paper).

In order to finish work with the app, choose the app, choose *Paper* and *Deactivation*.

16.13 Density determination*

*This app is available in special version balances on demand.

This function allows for determination of solid body density, upon the basis of weight in the air and weight of material immersed in liquid of known density, according to the formula:

$$\rho = \frac{m_1}{m_1 - m_2} * \rho_{\text{liquid}}$$

where:

m₁-mass in the air

m₂-mass in the liquid

The measurement consists of two phases:

Phase I – solid body sample measurement in the air

Phase II – measurement with immersion in the liquid

This function also allows for determination of liquid density, upon the basis of plunger weight (with known density) in the air and tested liquid. The following formula is used:

$$\rho = \frac{m_1 - m_2}{V}$$

where:

m₁-plunger mass in the air

m₂-plunger mass in the liquid

V – plunger volume

The plunger volume is indicated on its hanger.

This measurement also takes place in two phases:

Phase I – plunger measurement in the air

Phase II – measurement with immersion in the liquid

More comprehensive description is delivered with the Hydro Set.

APPLICATIONS	
<input type="checkbox"/>	...
<input type="checkbox"/>	Density
<input type="checkbox"/>	...
	Exit

DENSITY	
1. Activate	
2. Preview	
3. Type of material:	<solid><liquid>
4. Type of liquid:	<Water><Ethanol><Other>
5. Liquid type: g/cm ³
6. Shortcut:	<-><F1><F2>...<F5>
7. Exit	

Applications option:

- *Activate* – density measurement,
- *Preview* – register check,
- *Type of material* – solid or liquid,
- *Type of liquid* – water, ethanol or other (inscribe density here),
- *Shortcut* – set fast access key for login user (if you have USB_A interface and PC keyboard connected).

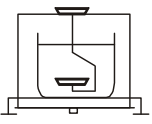
Max ...	Min ...	e= ...	d= ..	II
				
→T← 0.0000 g				
0% _____ 100%				

Actions order for solid material:

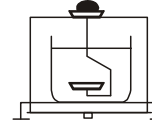

After choosing material type, liquid type or density, after choosing *Activate* tare the balance using →T← key.

Max ...	Min ...	e= ...	d= ..	II
				
ENTER 10.0900 g				
0% _____ 100%				

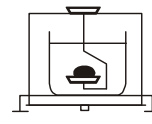
Put material on upper pan (measurement in air) and press *ENTER*.

Max ...	Min ...	e= ...	d= ..	II
				
ENTER 8.0910 g				
0% _____ 100%				

Put material on lower pan (measurement in liquid) and press *ENTER*.

DENSITY/PREVIEW	
	Mass in the air : 10.090g
	Mass in the liquid : 8.0910g
	Mass density : 5.0370g/cm ³
	Density with comp.: 5.0360g/cm ³
 - print	 - exit

Results will display and available options:

 -printout,

CLR - exit to summing.

In order to finish work with the app, choose the app and *Deactivation*.

DENSITY

1. Activate
2. Preview
3. Type of material: <Solid><Liquid>
4. Plunger volume: <-><F1><F2>...<F5>
5. Shortcut: <-><F1><F2>...<F5>
6. Exit

Application options:

- *Activate* – density measurement activation,
- *Preview* – register check,
- *Type of material* – solid or liquid,
- *Plunger volume* – inscribe volume value of the plunger,
- *Shortcut* – set fast access key for login user (if you have USB_A interface and PC keyboard connected).

Max ... Min ... e= ... d= .. II

→T←

0% | | 100%

Actions order for liquid:

After choosing liquid, inscribing plunger volume and choosing *Activate* press →T←.

Max ... Min ... e= ... d= .. II

ENTER

0% | | 100%

Hang plunger (without diving it in liquid) – measurement in air – and press *ENTER*.

Max ... Min ... e= ... d= .. II

ENTER

0% | | 100%

Hang plunger in liquid – measurement in liquid – and press *ENTER*.

DENSITY/PREVIEW

ρ	Mass in air	: 10.090g
	Mass in liquid	: 8.091g
	Liquid density	: 5.037g/cm ³
	Density with comp.	: 5.036g/cm ³

☐ - printout CLR - exit

Results will display and below options:

- ☐ - memory printout,
- CLR - return to summing .

In order to finish work with the app, choose the app and *Deactivation*.

Report printout:

In order to printout results connect printer to scale's RS232C interface. Connection description can be found in "Detailed information about balance communication" chapter.

After each measurement print can be obtained by using  key.

Printout example:

Measurement number	=	
Mass in the air	=	... g
Mass in the liquid	=	... g
Density ...	=	... g/cm ³
Density with comp.	=	... g/ cm ³
Water density	=	... g/cm ³
Water temperature	=	... °C

16.14 Recipe

This app allows for weighing few ingredients in sequence in one vessel, with the possibility of continuous reading of summary mass value of all ingredients weighed so far.

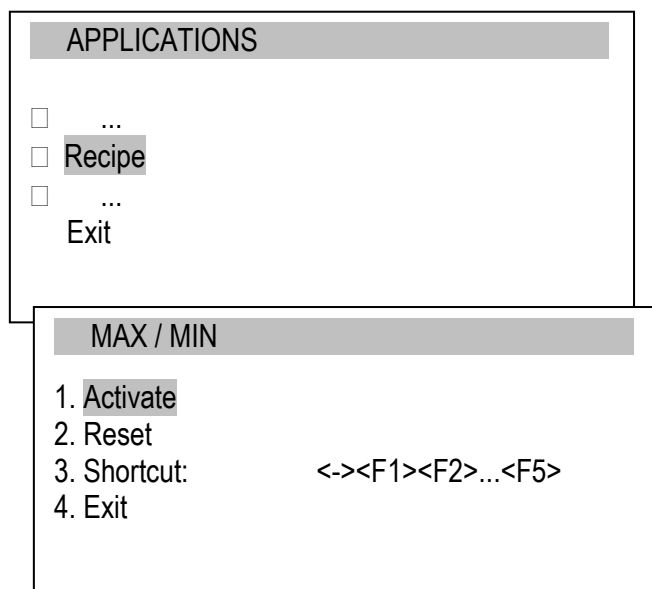

Application options:

- *Activate* – recipe function activation,
- *Reset* – results reset,
- *Shortcut* – set fast access key for login user (if you have USB_A interface and PC keyboard connected).

Actions order:

Put vessel on pan and tare ($\rightarrow T \leftarrow$) the scale.

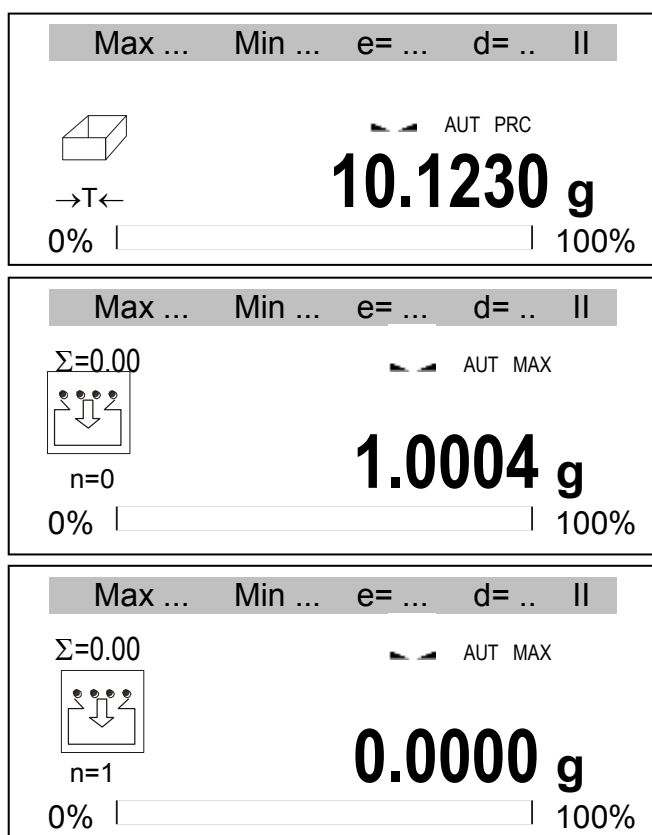

The balance is ready for weighing the successive ingredients, and after each ingredient it is necessary to press $\rightarrow T \leftarrow$ key. It will zero the balance indications. On the left side the sum of previously weighed ingredients (Σ) and their number (n) is displayed.

To read the total mass of all weighed ingredients use \curvearrowright key (pressing it again will cause return to ingredient weighing).

In order to finish work with the app, choose the app and *Deactivation*.

17. Measurements*

* Measurements are available in balances with optional ALIBI memory.

Measurements function enables to view and send (to computer or printer) last 1000 measurements.

MENU

1. Applications
- 2. Measurements**
3. Setup
4. Info

MEASUREMENTS ↵ printout

ID=1000 2018-12-11 10:33:43
 ID=999 2018-12-11 10:25:09

 ID=1 2017-10-10 8:30:01

ID:1 ↵ printout

DATE: 2017-10-10	NET: 1000.85 g
TIME: 8:30:01	GROSS: 1010.85 g
NUM: 1	TARE: 10.00 g
USER_ID: 2	STB: 1
PROD_ID: 12234	

The measurements are displayed in order starting from the newest. Remember that only “confirmed” (confirmation can be made manually or automatically, more info in *Interface parameters setting* chapter option *Sending*) measurements are stored in memory.

User can view measurements using navigation keys or press ↵ to send them to computer/printer.

If user selects (by pressing *Enter*) one of the measurements he can get detailed info about the measurement. It is also possible to send (to computer/printer) single measurement data by pressing ↵ key.

Printout example of all measurements:

```

MODEL      : AKA1200G
S/N        : 12345678
PROD.DATE  : 2018-12-19
REC.COUNT  : 2
REC_ID;DATE;TIME;NUM;USER_ID;PROD_ID;NET;GROSS;TARE;UNIT;POINT;STB
1000;2018-07-11;10:33:43;2;2;1;1101.07;1111.08;10.01; g ;2;1
999;2018-07-11;10:25:09;1;2;1;1000.85;1010.85;10.00; g ;2;1
...
1;2017-01-01; 8:30:01;1;2;1;1000.85;1010.85;10.00; g ;2;1
  
```

Printout example of single measurement:

```

MODEL      : AKA1200G
S/N        : 12345678
PROD.DATE  : 2018-12-19
REC.COUNT  : 2
REC_ID;DATE;TIME;NUM;USER_ID;PROD_ID;NET;GROSS;TARE;UNIT;POINT;STB
1;2017-01-01; 8:30:01;1;2;1;1000.85;1010.85;10.00; g ;2;1
  
```

18. Detailed information about balance communication

Below important information about serial ports.

18.1 Long protocol description

Transmission proceeds in the following way:

1. Communication parameters: 8 bits, 1 stop bit, no parity, baud rate 9600bps,
2. Available orders send from computer and balance answers:

- Readout of scale indication (corresponds to pressing  key

Computer→Scale: **S I** CR LF (53h 49h 0Dh 0Ah),

Scale→Computer: scale response according to description below (16 bytes):

Byte	1	-	sign „-“ or space
Byte	2	-	space
Byte	3÷4	-	digit or space
Byte	5÷9	-	digit, decimal point or space
Byte	10	-	digit
Byte	11	-	space
Byte	12	-	k, l, c, p or space
Byte	13	-	g, b, t, c or %
Byte	14	-	space
Byte	15	-	CR
Byte	16	-	LF

Attention:

Network number different than zero (*SErIAL / nr* function) changes scale working mode: communication with a computer is possible after logging the scale in with 02h scale number command. To log the scale out use 03h command.

For example: Using a program to test RS232 interface (program is available on www.axis.pl in computer programs section) for scale number 1 please write: \$0201 to log in, then *SI*, and write: \$03 to close communication.

- Asking for scale presence in system (testing scale connection with computer):
 Computer→Scale: **S J** CR LF (53h 4Ah 0Dh 0Ah),
 Scale→Computer: **M J** CR LF (4Dh 4Ah 0Dh 0Ah),
- Displaying a sign on scale display (text message from computer):
 Computer→Scale: **S N** n n X X X X X X CR LF (53h 4Eh 0Dh 0Ah), nn-displaying time in seconds; XXXXXX- signs to display
 Scale→Computer: **M N** CR LF (4Dh 4Eh 0Dh 0Ah),
- Scale tarring (calling $\rightarrow T \leftarrow$ key press) :
 Computer→Scale: **S T** CR LF (53h 54h 0Dh 0Ah),
 Scale→Computer: without response,
- Scale zeroing (calling $\rightarrow 0 \leftarrow$ key press):
 Computer→ Scale: **S Z** CR LF (53h 5Ah 0Dh 0Ah),

Scale →Computer: without response,

- Scale turning on / off (calling $\text{I/}\text{O}$ key press):
 Computer → Scale: S S CR LF (53h 53h 0Dh 0Ah),
 Scale →Computer: without response,
- Entering to special function menu (calling *MENU* key press):
 Computer → Scale: S F CR LF (53h 46h 0Dh 0Ah),
 Scale →Computer: without response,
- Setting low threshold value (option):
 Computer → Scale: S L D1...DN CR LF (53h 4Ch D1...DN 0Dh 0Ah)
 D1...DN – threshold value, maximum 8 characters („-” – negative value, digits, dot – decimal separator), number of digits after dot should be the same as on scale display,
 Scale →Computer: without response,
- Example:
 - in order to set low threshold 1000g in scale B1.5 (d=0.5g) the following order should be sent:
 S L 1 0 0 0 . 0 CR LF (53h 4Ch 31h 30h 30h 2Eh 30h 0Dh 0Ah),
 - in order to set low threshold 100kg in scale B150 (d=50g) the following order should be sent:
 S L 1 0 0 . 0 0 CR LF (53h 4Ch 31h 30h 30h 2Eh 30h 30h 0Dh 0Ah),)
- Setting high threshold value (option):
 Computer → Scale: S H D1...DN CR LF (53h 48h D1...DN 0Dh 0Ah),
 D1...DN – threshold value (see)
 Scale →Computer: without response.

Connecting cable WK-1 (scale – computer / 9-pin interface):

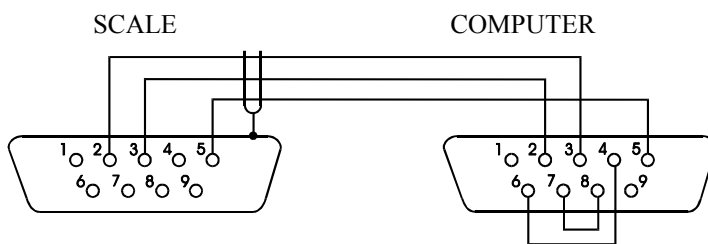

Connecting cable WD-1 (connects printer with scale):

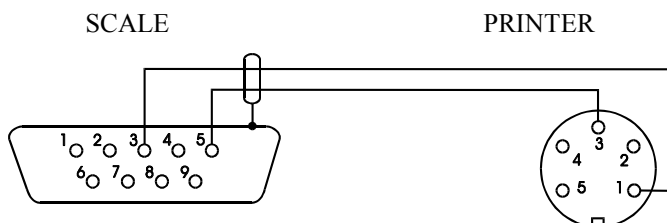

AXIS C-001 printer internal switches setting:

SW-1	SW-2	SW-3	SW-4	SW-5	SW-6	SW-7	SW-8
on	off	on	off	off	on	off	off

18.2 Protocol EPL description

Transmission parameters: 8 bits, 1 stop bit, no parity, baud rate 9600bps,

- After using  key in scale:
- Scale→Label printer : set of instruction in EPL-2 language that initialize label printing:

US	- Steering instruction
FR"0001"	- Label number define instruction
?	- Instruction that starts list of variable signs
mm:gg	- 5 signs: minutes:hour
rrrr.mm.dd	- 10 signs: year.month.day
masa	- 10 signs: scale indication+ mass unit
P1	- Steering instruction

Attention:

5. Except variable signs constant signs can also be inscribed e.g. factory name, product name and so on.
 6. In standard only one label pattern is possible to printout (number 0001). Using bigger amount of patterns (other label numbers) is possible thanks to *LABEL* special function.
 7. To achieve label printout, label printer must have inscribed label pattern (label pattern is created on computer and using computer it is saved to label printer memory). Label pattern is designed by ZEBRA DESIGNER program which is supplied together with label printer.
- Scales parameters and transmission protocol must correspond to label printer type.

19. Troubleshooting and maintenance

1. The balance should be kept clean.
2. Take care that no dirt is between the casing and the pan. If a dirt is noticed, take off the pan (lift it up), clean a dirt and then mount the pan.
3. In case of improper operation caused by a short-lasting lack of power supply, switch the balance off by unplugging it from the mains, and then after several seconds switch it on.
4. All repairs of the balance should be performed by authorised service centre.
5. To repair a balance, please contact nearest service centre. The list of authorised service centres is given in guarantee card.
6. Balances can be sent for repair as messenger delivery only in original package, if not, there is a risk of damaging the balance and loosing guarantee.

Failure messages:

Message	Possible cause	Recommendation
"Test ..."	auto-tests are in progress / damage of electronic unit	wait for 1 minute
" - - - - "	unfinished zeroing / mechanical damage	wait for 1 minute check if the balance is placed on stable ground, not affected by vibrations
"Internal calibration: load error"	too small load or overloading balance mechanism / mechanical damage	check if there are mounted all necessary pan elements or if there is no load on the pan
„Tare range exceeded”	tare key pressed during zero indication	balance indications must be different from zero
„Zeroing range exceeded”	permissible zeroing range was exceeded	take a load off the pan
„Weighing range exceeded”	permissible weighing range (Max +9e) was exceeded	reduce a load on the pan
„Measuring range exceeded (+)”	upper limit of measuring range in analogue-digital converter was exceeded	take a load off the pan
„Measuring range exceeded (+)”	lower limit of measuring range in analogue-digital converter was exceeded	check if there are mounted all necessary pan elements
„Unit weigh is too small”	entered unit weigh is too small	unit weight is too small or entered number of pieces is too big