



USER MANUAL

TORQUE TESTER

FSC Series

Contents:

| | | |
|---------|---|----|
| 1. | Introduction | 3 |
| 2. | Basic Set | 3 |
| 3. | Safety instructions | 4 |
| 3.1 | Main safety rules | 4 |
| 3.2 | Safety rules | 5 |
| 3.2.1 | Transport safety rules | 5 |
| 3.2.2 | Safety rules during start-up and operation | 5 |
| 3.2.3 | Safety rules during conservation | 6 |
| 4. | Fast start | 7 |
| 5. | Force meter general view | 8 |
| 6. | Technical data | 9 |
| 7. | Keys and indicators | 10 |
| 8. | Preparing the force gauge for operation | 11 |
| 9. | Turning on the force gauge | 12 |
| 10. | Accumulators exchange | 13 |
| 11. | Description of measurement methods | 14 |
| 11.1 | Measuring actual and peak value of a pressure/pull force | 14 |
| 11.2 | Force characteristics measurement, measurement registration to memory | 15 |
| 12. | Connecting external devices | 16 |
| 13. | User's Menu | 17 |
| 13.1 | Measurement | 17 |
| 13.1.1 | Measurement speed | 18 |
| 13.1.2 | Units | 18 |
| 13.1.3 | Auto-zeroing | 20 |
| 13.1.4 | Comparison with threshold values MIN / OK / MAX | 21 |
| 13.2 | Memory | 22 |
| 13.2.1 | Gathering results | 23 |
| 13.2.2 | Presentation of collected measurements (Statistics) | 24 |
| 13.2.3 | Save, read, erase memory (Statistics) | 24 |
| 13.3 | Configuration | 26 |
| 13.3.1 | Setting serial ports | 27 |
| 13.3.2 | Force meter calibration | 28 |
| 13.3.3 | Information | 29 |
| 13.3.4 | Setting date and time | 30 |
| 13.3.5 | LCD settings | 31 |
| 13.3.6 | Selecting the menu language | 32 |
| 13.3.7 | Printout settings | 33 |
| 13.3.8 | Turning the sound ON/OFF when using the keypad (beep) | 34 |
| 13.3.9 | Automatic power OFF (Auto-OFF) | 34 |
| 13.3.10 | Monitoring the batteries' charge level (Battery) | 35 |
| 13.3.11 | External input | 37 |
| 13.3.12 | Firmware update | 37 |
| 13.3.13 | Defaults | 38 |
| 14. | Maintenance, troubleshooting and repairing minor types of damage | 39 |
| 15. | FSC menu diagram | 40 |

1. Introduction

The FSC series torque testers produced by AXIS Sp. z o.o. are designed for dynamic measuring of torque in manufacturing and quality control applications particularly to check/calibrate tension wrenches.

Measurements results can be presented as graph or histogram and saved on microSD cards.

The RS232C and USB interface allows the measurement results to be transmitted to a computer or a printer for further analysis or recording.

2. Basic Set

The basic set includes the following elements:

1. Force gauge (meter + sensor),
2. Accumulators NiMH 2700mAh – 4 pcs.
3. Power supply unit ~230 V 50 Hz / =12 V; 1.25 A,
4. Case
5. Force gauge-computer cable
6. CD containing an operation manual and software,
7. Warranty.

3. Safety instructions

3.1 Main safety rules

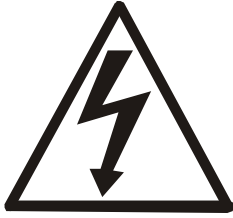

Read carefully the safety instructions included below. Observe these instructions to avoid electrocution or damage to the force gauge itself or other devices connected to the force gauge.

- Repairs and any necessary adjustments may only be conducted by qualified personnel.
- Do not use the force gauge when any part of the enclosure has been removed.
- Do not use the force gauge in potentially explosive atmospheres.
- Do not use the force gauge in areas with a high humidity.
- In the case of suspected damage to the force gauge, turn off the gauge and do not use it until it is examined by a specialised servicing facility.

3.2 Safety rules

3.2.1 Transport safety rules



Force meter and included equipment should be transported from producer to receiver in original company box.

To transport force meter during exploitation original producer case should be used.

3.2.2 Safety rules during start-up and operation

Force meter with equipment supplied by producer is a safe device, what was achieved by application of fire protection and elimination of mechanical, chemical, explosive etc threads.

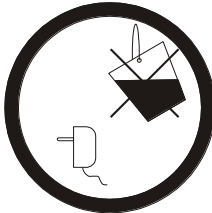
In order to avoid danger we suggest to:

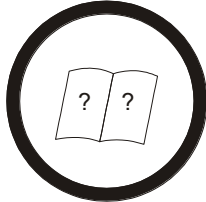
| Lp. | Recommendation | Warnings |
|-----|---|---|
| 1 | Avoid contact with flood, water or other liquids due to high voltage 230V. |  |
| 2 | Damaged accumulators handle with care. Use rubber gloves and safety glasses if necessary. |  |
| 3 | The proper disposal of used force meter. |  |
| 4 | User manual training. |  |
| 5 | Periodic monitoring of connections | <div style="border: 1px solid black; padding: 5px; width: fit-content;"> Next control date: </div> |

Specific recommendation:



Risk of electric shock due to the use of ~230V 50Hz voltage via external feeder. It is unacceptable to spill the feeder or use it when the enclosure is damaged cause it may cause electric shock.



In order to avoid leakage of electrolyte from accumulators immediate disposal of used accumulators from force meter is suggested.

3.2.3 Safety rules during conservation

Force meter doesn't need conservation except accumulators exchange when used – that happens when after full recharge the force meter working time is shorter more than 20% from the value suggested by producer.



If the device seems to be damaged immediately stop operation.

4. Fast start

Prepare force meter to work by selecting proper measuring tip (force gauge with internal sensor) or after mounting proper working post (force gauge with external sensor).

Turn on force meter by using *ON/OFF* key and leave the device in stationary position. That will enable zeroing, software version displaying and zero indication. Force meter is ready to work after following screen displays:

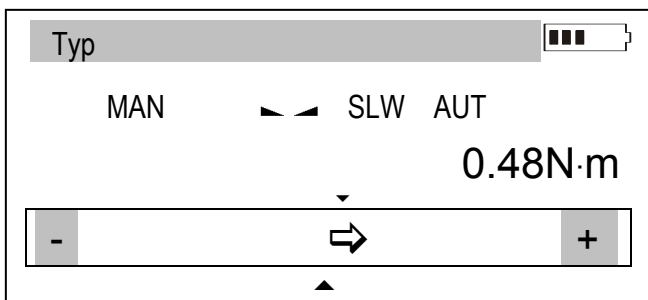
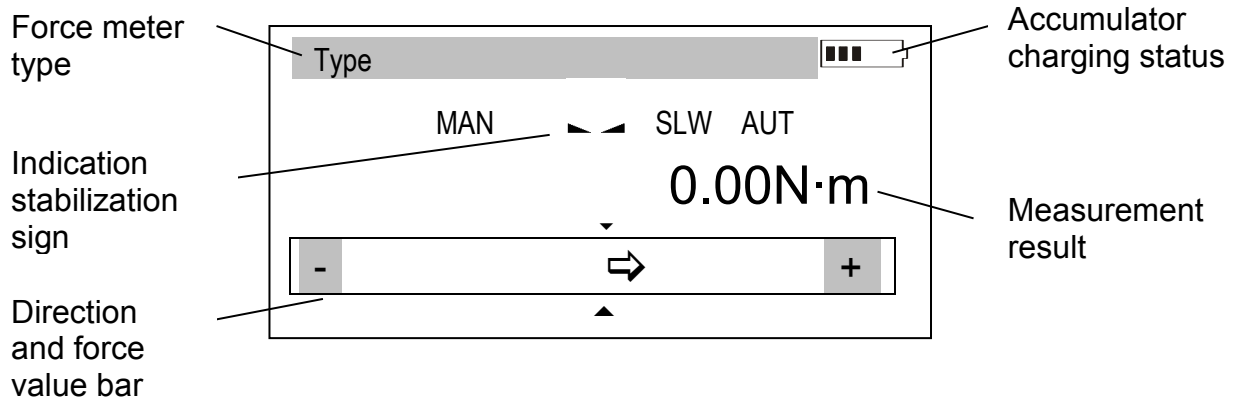

The force measurement is continuous. Display continuously indicates actual force value measured by meter. Force direction is signalized by an arrow in lower part of screen and a sign + (pressing force) or - (pulling force). Saving actual force indication to memory is done by pressing *MEM* key.

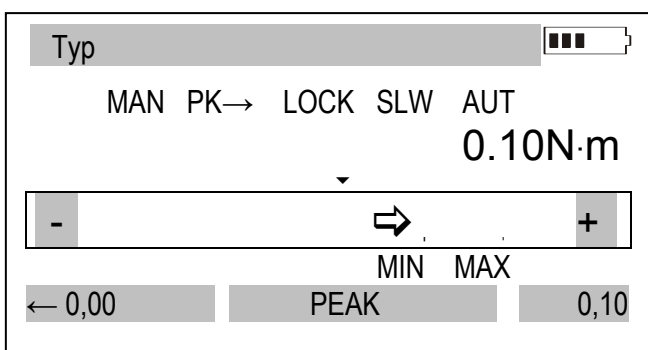

Changing actual torque value indication into peak value measurement is done by pressing *PEAK* key. Indication stabilization sign changes into *LOCK* sign and force meter changes mode into peak value in one directions. Pressing again *PEAK* key changes peak torque direction: first for pressure force (*PK↑*) and after another *PEAK* pressing for pulling (*PK↓*), zeroing is done by *→0←* key.

Attention:

Dynamical forces measurement should be carried out by saving to memory series of measurements with given sample time, then display force characteristics and statistical results (rozdz. 14.3 *Memory*).

5. Force meter general view

FSC force meter:

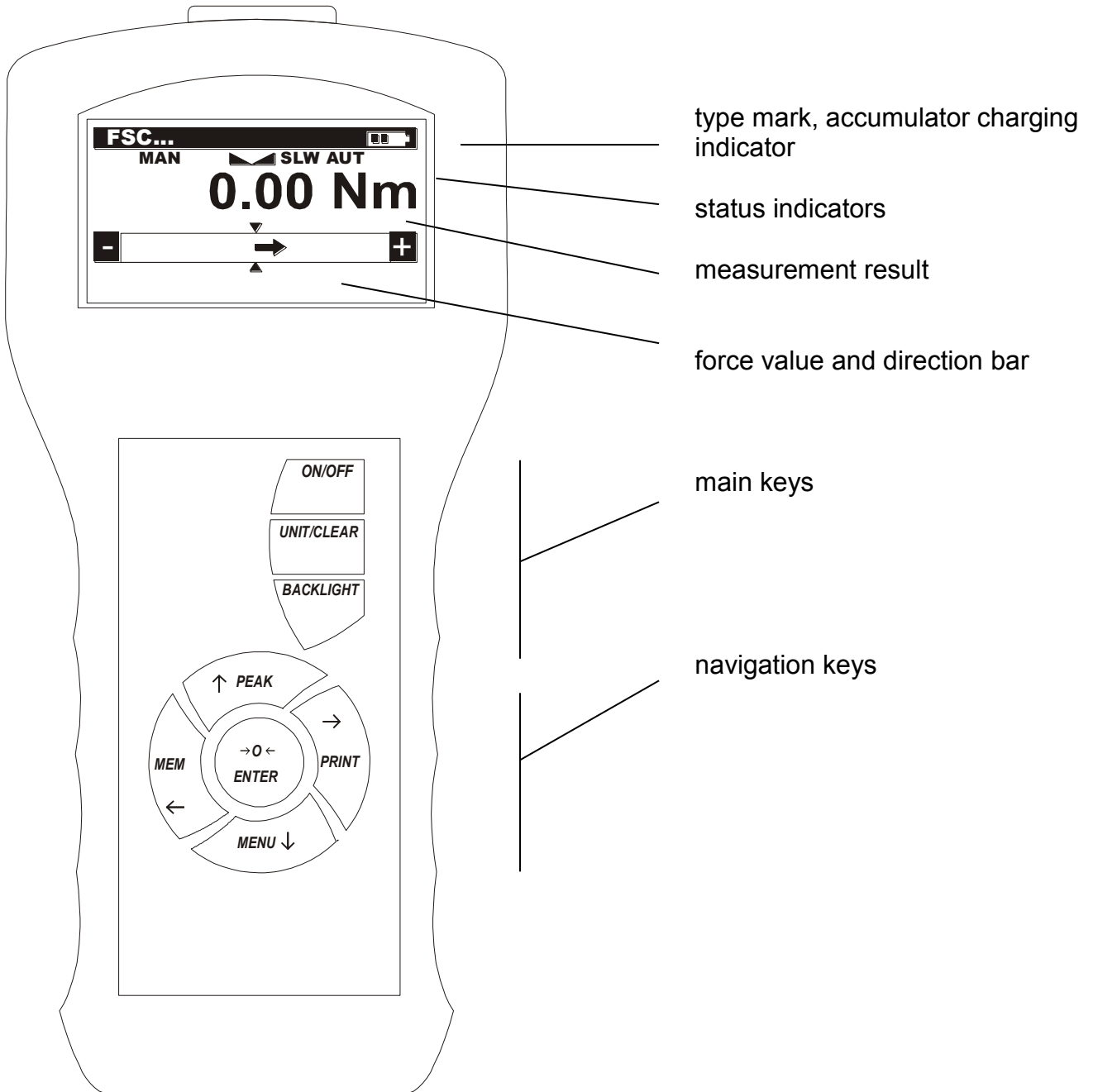

6. Technical data

| Type | FSC2 | FSC5 | FSC10 | FSC100 | FSC500 |
|--------------------------|---|---------|--------|--------|--------|
| Maximum force measured | 2Nm | 5Nm | 10Nm | 100Nm | 500Nm |
| Reading graduation (d) | 0,001Nm | 0,002Nm | 0,01Nm | 0,1Nm | 1Nm |
| Accuracy | ±0,5% F.S. | | | | |
| Measurement units | Nm, N*cm, kgf*m, gf*m, lbf*in | | | | |
| Operating temperature | -10 ÷ 40°C | | | | |
| Internal resolution | 24 bits (16mln graduation) | | | | |
| Process speed | Regulated max 1000 measurements/s | | | | |
| Internal memory capacity | 1x6400 measurements | | | | |
| Interface | RS-232C and USB, options: Bluetooth, WE trigger gate, WY transoptor MicroSD card slot: compatibility with SDSC (standard) cards and SDHC class 4 | | | | |
| Assisting software | FM (time characteristics, statistic analysis, data archiving) | | | | |
| Display | LCD graphical | | | | |
| Measurement options | Maximal value measurement, serial measurement, dynamic measurement (time diagrams) | | | | |
| Power supply | Ni-Mh batteries set 2700mAh + supply ~230V 50Hz / 12V 1,2A | | | | |
| Accumulator working time | ~20h (~45h backlighting off) | | | | |
| Dimensions | 215x100x40mm (meter) | | | | |
| Weight | 430g (without batteries) | | | | |

7. Keys and indicators

| | |
|-------------------|--|
| | <i>Main keys:</i> |
| ON/OFF | - ON / OFF key (standby), |
| UNIT/CLEAR | - Change units / cancel selection or change a parameter value, - <i>Press and hold</i> – move to measurement menu (Statistics/Reset)/return |
| BACKLIGHT | - Turn on illumination (ECO mode), |

| | |
|--------------|---|
| | <i>Navigation keys:</i> |
| ↑ | - Move cursor up or increase the digit marked by the cursor, |
| ↓ | - Move cursor down or decrease the digit marked by the cursor, |
| → | - Move to the next menu level or display the next option, |
| ← | - Move to the previous menu level or display the previous option, |
| ENTER | - Confirm the entered parameter or select a highlighted option. |

| | |
|--------------|--|
| | <i>Function Keys:</i> |
| MENU | - Meter function menu (diagram menu - chapter 18), |
| PEAK | - Measure the maximum value, |
| MEM | - Save the result to the memory, press and hold – save to memory menu, |
| PRINT | - Print result (transmission via RS-232C connector). |
| →0← | - Force meter indications zeroing |

| | |
|-------------------|--|
| | <i>Status indicators:</i> |
| MIN/OK/MAX | - Indications below MIN; in range MIN÷MAX; above MAX |
| MAN/ACQ | - Manual/automatic measurements mode |
| ▴ ▾/LOCK | - Indicates that the weighing result has stabilised, |
| PK↑ / PK↓ | - Direction of measured force, - |
| SLW/FST | - Slow/fast measurement mode, |
| AUT | - Autozeroing on |
| SD | - microSD card mounted |

Note:

Numbers are entered using the navigation keys. First, the cursor is placed in the right digit position.

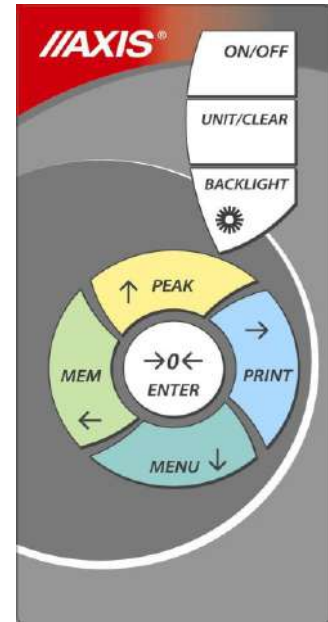

8. Preparing the force gauge for operation



If the force gauge has been transported from an area with low temperature to an area with a higher temperature, e.g. during winter, water may condensate on the gauge's enclosure. In such a case, do not turn on the gauge's power supply, as it may lead to damage to the gauge or improper operation. Before turning on the gauge, leave it for 1 hour to acclimatise.

9. Turning on the force gauge

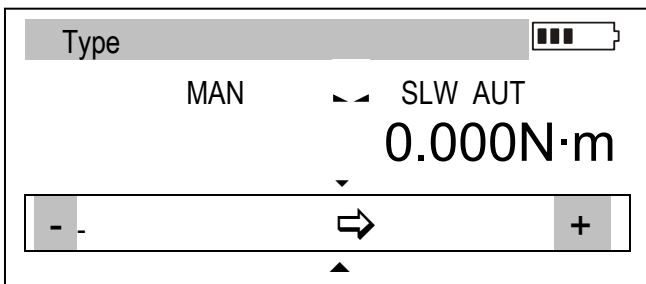
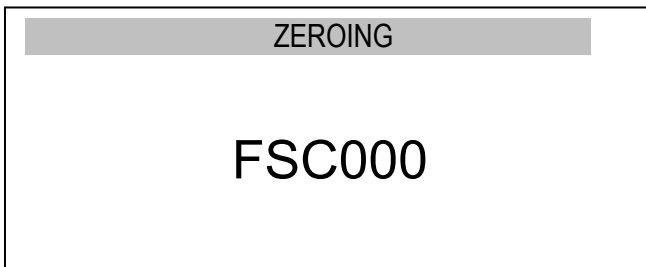
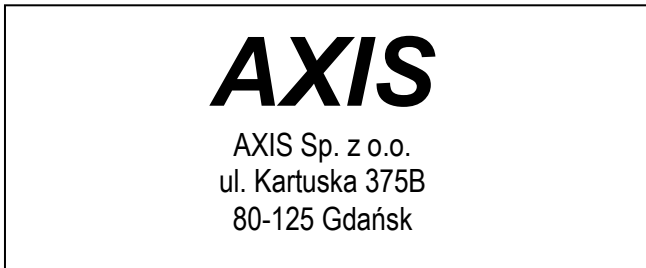

Place the gauge in the operating position, e.g. horizontal position (by laying it on a table). Turn on the gauge by pressing the *ON/OFF* key.

When necessary, plug the gauge's power supply unit to a ~230 V/50 Hz socket and connect the power supply unit's plug to the gauge's 12 V socket.

The gauge automatically tests the electronic subassemblies and then resets. During this operation, the gauge should remain stationary and its sensor should not be affected by any forces.

After the resetting has been successfully completed, the gauge indicates zero.

Unsuccessful resetting is signalled by an appropriate message.

Note:

It is possible to accelerate the resetting process by pressing the *MENU* key, which will recall the results from the previous resetting.

If the batteries are low, leave the gauge's external power supply unit ON until they are fully recharged. The batteries' charge level is signalled by an indicator in the upper section of the display.

10. Accumulators exchange

If during exploitation time working time of fully charged accumulators shortens to 20% of the nominal value (under 4h), replace them with new ones.

In order to exchange accumulators open the cover by tilting bracket and put new ones as indicated at the bottom of the housing (correct polarization).

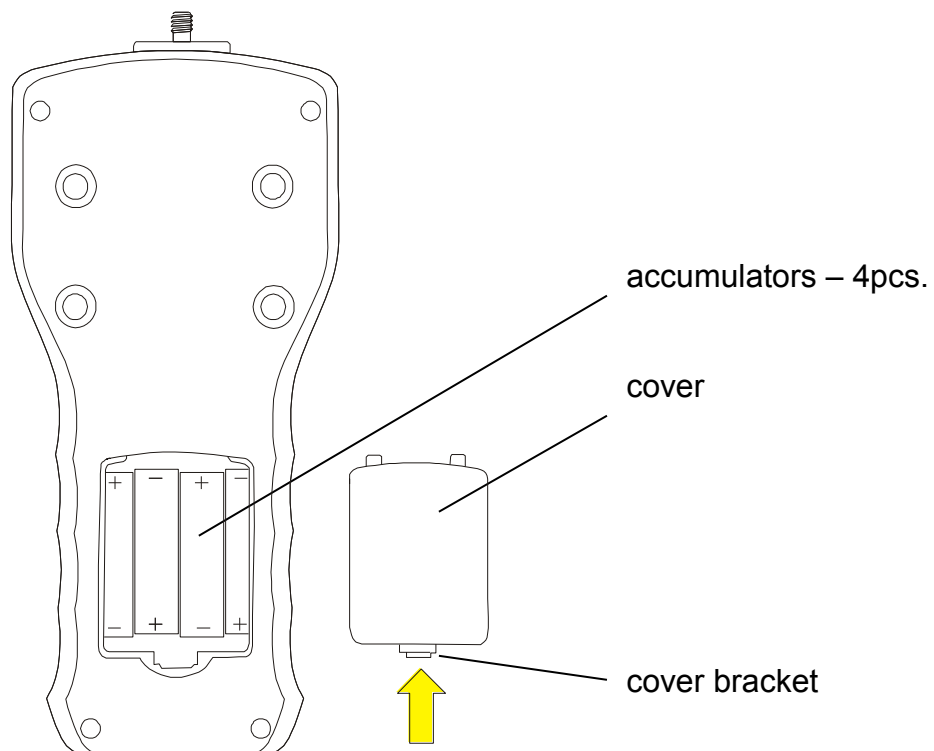

11. Description of measurement methods

11.1 Measuring actual and peak value of a pressure/pull force

The zeroing process starts automatically after turning on the gauge or by pressing the $\rightarrow 0 \leftarrow$ key.

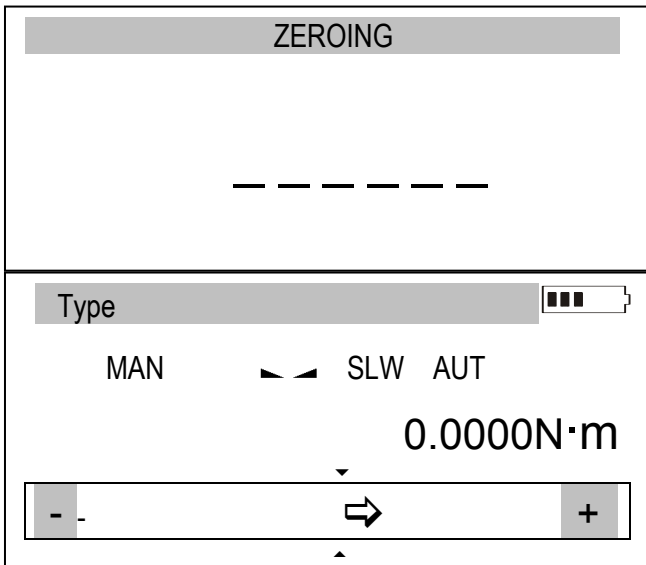

To perform the measurement, indicate the force direction using an arrow in the display's lower bar section and "+" or "-" symbol.

To change the measurement from the actual value (continuous measurement) to the maximum value (peak measurement), use the *PEAK* key – stabilization indicator is replaced by *LOCK* indicator. Pressing again *PEAK* button will change direction of the measured force (*PK* \rightarrow , *PK* \leftarrow), zeroing by using $\rightarrow 0 \leftarrow$ key.

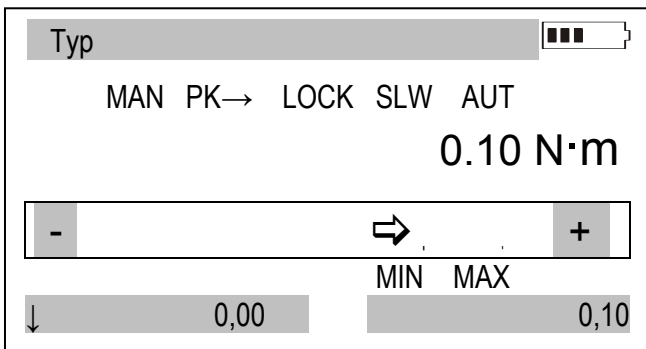

When measuring maximum value, at the bottom of the screen appears a bar showing actual force value and maximum force value for other force direction if it was measured before - otherwise 0,00 value will indicate.

11.2 Force characteristics measurement, measurement registration to memory

In order to enable changing force measurement and to create results visualizations (graphs or histograms), force gauge is equipped with actual results buffer memory (RAM), EEPROM memory and microSD card (option). Detailed description of available options can be found in 14 chapter.

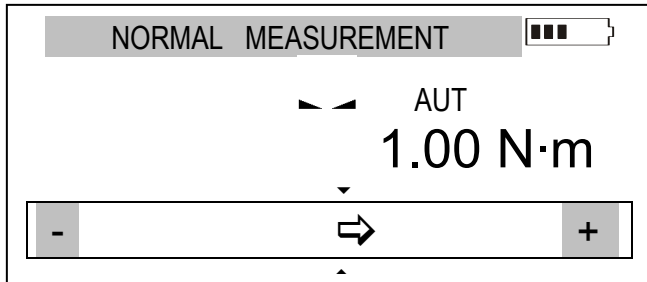

After pressing MEM key results are stored in buffer memory. Quantity of result in a 1 serie is set in *Memory/Setting/Quantity* .

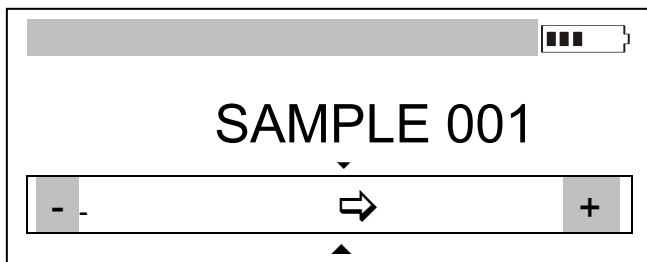

If indicator *MAN* (manual mode) is displayed, after pressing *MEM* key single measurement is stored.

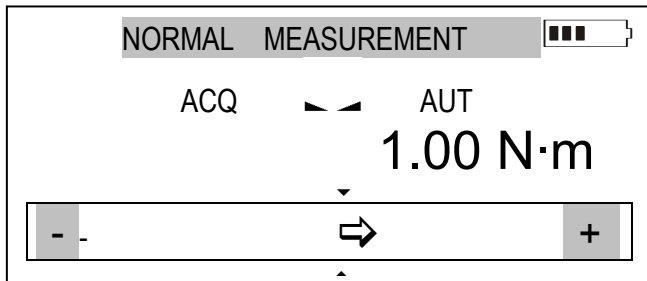

When ACQ indication is turned on, *MEM* key starts storing measurements in equal time intervals.

During storing measurements successive sample numbers are displayed and total quantity.

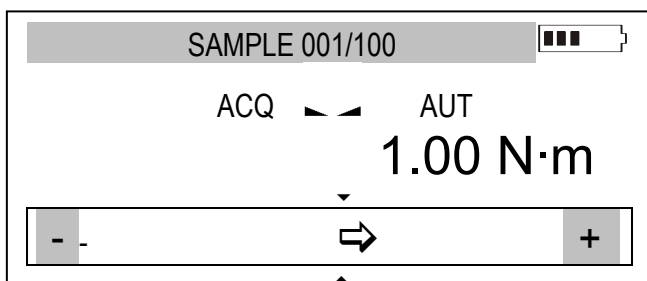

During measurement storing, numbers of samples and total sum of samples are displayed.

After storing all samples a graph is displayed.

ENTER – returns to force indications, *MEM* – *Statistics* results displaying. *Statistics* option is used for obligatory storing or deleting actual results (next measurement is possible only after deleting).

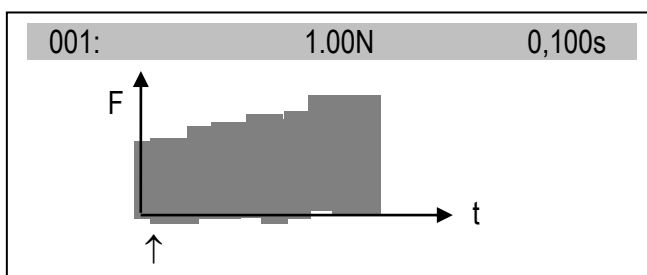

UNIT/CLEAR enables quick exit from *Statistics* option.

12. Connecting external devices

The force gauge is equipped with a socket for an external power supply unit, RS232C interface (RJ joint), USB interface and optional THR (thresholds) output.

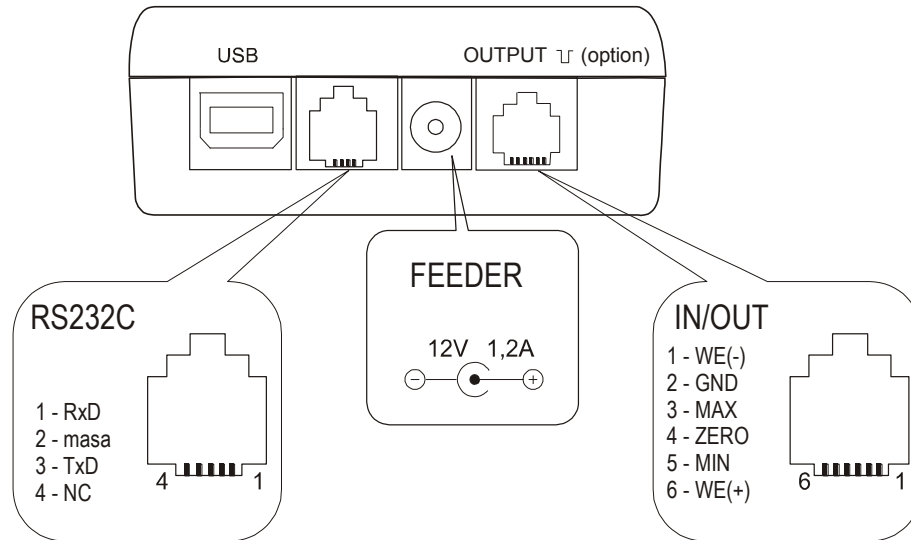

Installation manual and drivers can be found on CD disc supplied together with force meter.

Joint ampacity OUTPUT: $I_{\max}=25\text{mA}$ / $U_{\text{nom}}=24\text{V}$ (open collector type, emitters connected– GND).

IN voltage range WE(+)/WE(-): $U_{\text{in}}=12\text{-}18\text{V}$ / $I_{\text{in max}}=50\text{mA}$

Description of the data transmission (USB, RS232) protocol when working with a computer (*LonG*):

The force gauge transmit the result as follows (8 bits, 1 stop, no parity, 4800 bps):

Computer→Gauge: initiating signal S I CR LF (53 h 49 h 0Dh 0 Ah),

Gauge→Computer: gauge indication according to the following format (16 bytes):

Description of individual bytes:

| | | |
|------|-----|-------------------------|
| byte | 1 | - “-“ or space |
| byte | 2 | - space |
| byte | 3÷4 | - digit or space |
| byte | 5÷9 | - digit, comma or space |
| byte | 10 | - digit |
| byte | 11 | - space |
| byte | 12 | - k, l, c, p or space |
| byte | 13 | - g, b, t, c or % |
| byte | 14 | - space |
| byte | 15 | - CR |
| byte | 16 | - LF |

13. User's Menu

The User's Menu includes all functions and options necessary to operate the gauge or extend its functionalities.

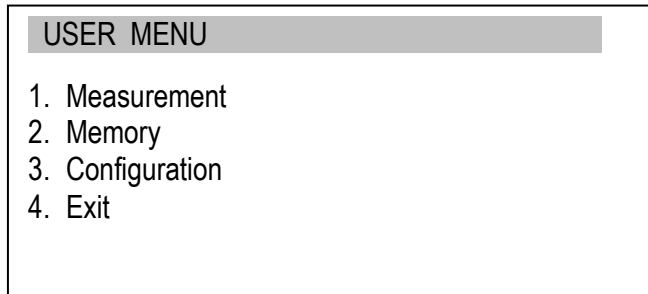

To use the options of the USER's MENU, use the *MENU* key. Move the cursor to the desired option and press *ENTER*.

The menu includes:

1. *Measurement* – measurement settings,
2. *Memory* – data readout and saving options,
3. *Configuration* – calibration and other options,
4. *Exit*.

13.1 Measurement

This selection includes the following functions to effectively assist you with the measurement:

- measurement speed in automatic mode,
- measurement unit choice,
- automatic zeroing,
- comparison with two threshold values (*MIN / MAX*),
- measured force direction change (accepted as plus +)

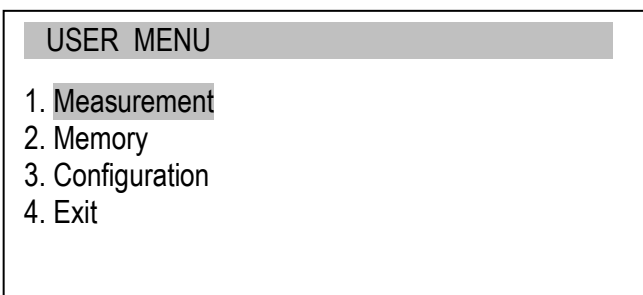

Move the cursor to *Measurement* and press *ENTER*.

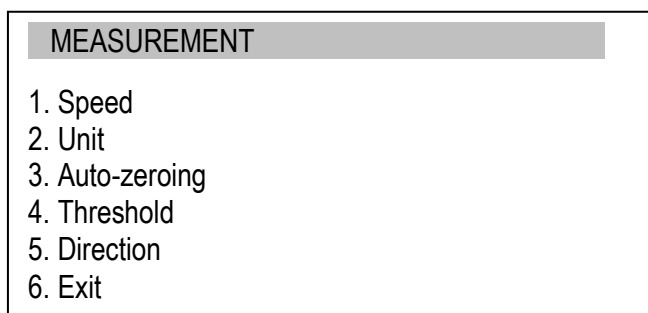

Move the cursor to the desired application and press *ENTER*.

13.1.1 Measurement speed

To obtain clear measurement results, it is recommended to adjust the speed of measurement to the dynamic properties of the measured object.

The image displays three sequential screenshots of a device's menu system, illustrating the steps to adjust measurement speed:

- USER MENU**
 - 1. Measurement
 - 2. Memory
 - 3. Configuration
 - 4. Exit
- MEASUREMENT**
 - 1. Speed
 - 2. Unit
 - 3. Auto-zeroing
 - 4. Threshold
 - 5. Direction
 - 6. Exit
- SPEED**
 - 1. Smp.time: 0.001 s
 - 2. Exit

Choose *Smp.time* and press *ENTER* to change sample time value using navigation keys.

13.1.2 Units

Torque units:

- newton-metre (N·m) – torque basic unit,
- newton-centimetre (N·cm): $1\text{N}\cdot\text{m} = 100\text{N}\cdot\text{cm}$,
- kilogram-metre (kg·fm): $1\text{N}\cdot\text{m} = 0,1020\text{kgf}\cdot\text{m}$,
- gram-force-metre (gf·m) : $1\text{N}\cdot\text{m} = 1020\text{gf}\cdot\text{m}$,
- pound-force-inch (lbf·in): $1\text{N}\cdot\text{m} = 8.85\text{lbf}\cdot\text{in}$.

To change the units, press the *UNIT/CLEAR* or *MENU* key several times.

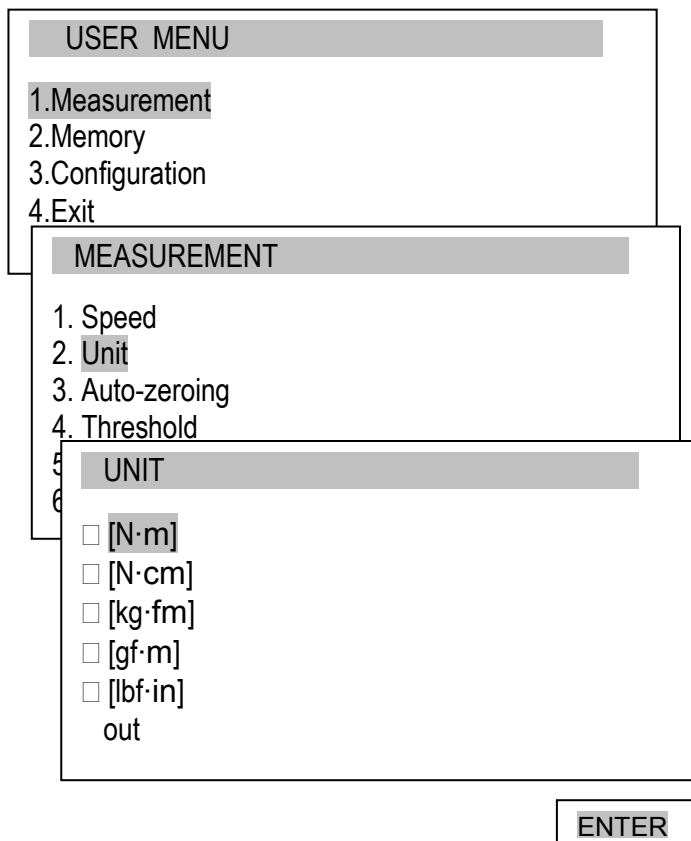

Press the *MENU* key, move the cursor to *Unit* and press *ENTER*.

Move the cursor to the desired unit and press *ENTER*.

During mass measurement the force meter measures gravitation force and converts it to mass. Calculating force and mass unit is depended to gravitation force of the place of measurement. Default value is the producer gravitation value $g = 9,81415\text{m/s}^2$. During very precise mass measurements ($\pm 0,1\%$ of range) it is crucial to inscribe proper gravitation value of the measurement place (*Calibration options*).

13.1.3 Auto-zeroing

When activated, this option automatically maintains zero indications on the gauge, if the gauge's sensor is not affected by any external force or if the zero indication was produced by pressing the $\rightarrow 0 \leftarrow$ key. The range of values (calculated in the gauge's reading graduation near zero) subject to the reset must be entered under the *Range* option (2 digits).

| | |
|-----------------|--|
| USER MENU | |
| 1.Measurement | |
| 2.Memory | |
| 3.Configuration | |
| 4.Exit | |
| MEASUREMENT | |
| 1. Speed | |
| 2. Unit | |
| 3. Auto-zeroing | |
| 4. Threshold | |
| 5. Direction | |
| 6. Exit | |

Use the navigation keys and *ENTER* to select *Status* and one of the following options:

- *ON* – auto-zeroing ON,
- *OFF* – auto-zeroing OFF.

Next, select *Range* and use \uparrow , \downarrow , \rightarrow , \leftarrow and *ENTER* to enter the auto-reset range (in reading graduation).

| | |
|--------------|------------|
| AUTO-ZEROING | |
| 1. Status | <ON> |
| 2. Range | 2 d |
| 3. Art.zero | <OFF><SET> |
| 3. Exit | |

| | | |
|---|---|-------|
| ↑ | ↓ | ENTER |
|---|---|-------|

| | |
|--------------|------------|
| AUTO-ZEROING | |
| 1. Status | <ON> <OFF> |
| 2. Range | 2 d |
| 3. Art.zero | |
| 4. Exit | |

| | | |
|---|---|-------|
| ← | → | ENTER |
|---|---|-------|

Additional option *Art.zero* enables to set device start zero to the value indicated before entering the *MENU*.

13.1.4 Comparison with threshold values MIN / OK / MAX

This selection includes the following functions to effectively assist you with the measurement:

- memory operations and data analysis,
- comparison with two threshold values (*MIN* / *MAX*).

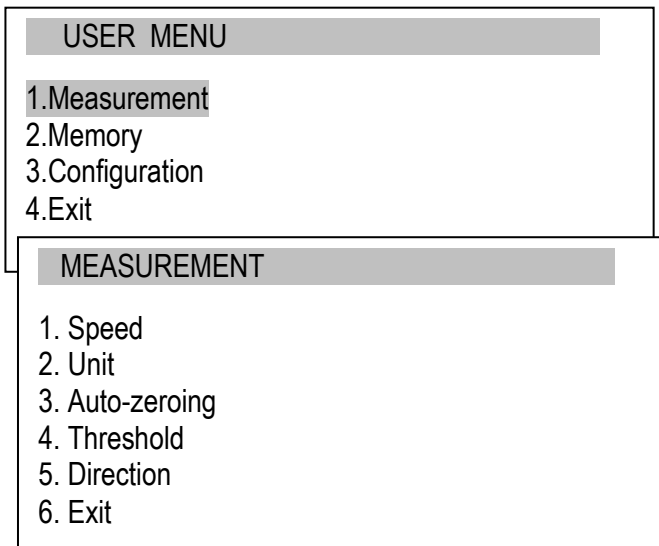

Move the cursor to *Applications* and press *ENTER*.

Move the cursor to *Threshold* and press *ENTER*.

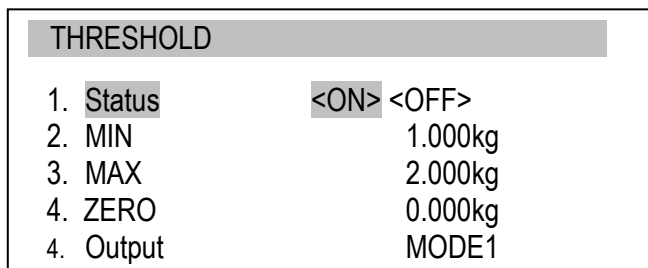

Activate the comparison by setting *Status* to *ON*:

- enter the *MIN* value – lower threshold,
- enter the *MAX* value – upper threshold,
- enter *ZERO* – zero signalling threshold.

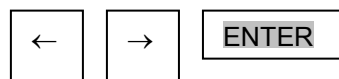

Select the option for *OUTPUT* and sound signalling (*Buzzer*):

- *MODE1* – short signal upon exceeding *MIN*, long signal upon exceeding *MAX*,
- *MODE2* – interrupted signal below *MIN*, above *MAX* – continuous signal, for *OK* – no signal.

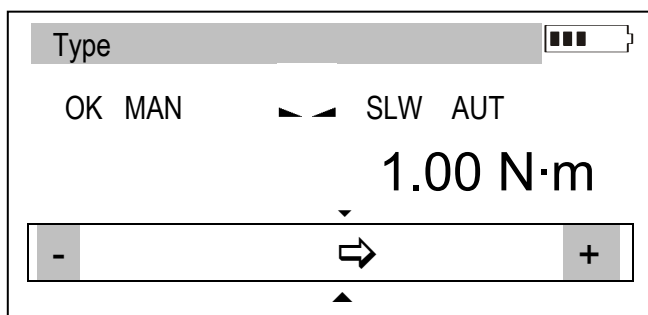

Exit the menu, start the measurement and observe the *MIN*, *OK* and *MAX* indicators on the gauge's display.

13.2 Memory

During measurements in automatic mode results are saved in volatile memory (RAM – erasing data after supply off). Saving, readout, erasing data (single series of measurements) in EEPROM and resetting volatile memory (RAM) is done by options in lower part of *Statistics* function screen. It is possible to view results on force meter (chart, histogram, table).

Using microSD card enables to save and later readout of many series of measurements in chosen file. It is possible to write custom names (inscribed by user) of folders and files.

MicroSD memory card can be put out from force meter in order to edit files on computer (.txt) and import them to other specialized software. In order to do that use microSD/SD adapter and readout files on computer.

Put microSD card into force meter using pushing element. The card plunges completely into housing and locks. SD or SDH (SDHC) icon appears on display. Push the card in order to unlock it.

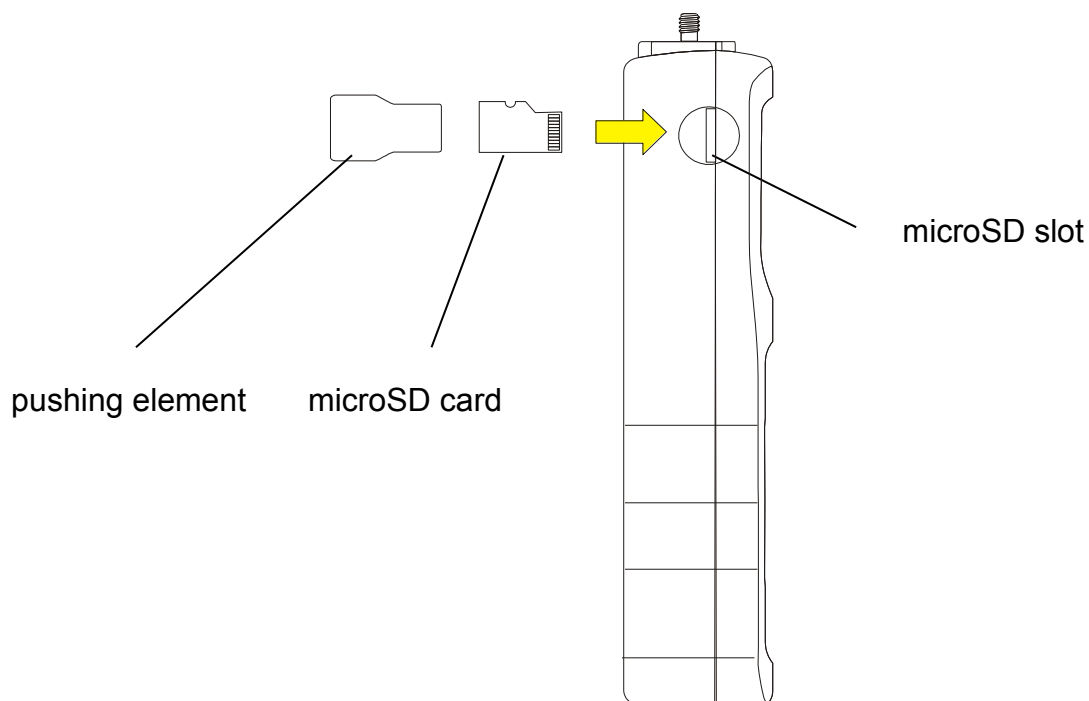

Memory option enables to:

- select gathering results mode,
- exposure of gathered measurements, storing , readout, deleting memory (*Statistics*),
- exit.

13.2.1 Gathering results

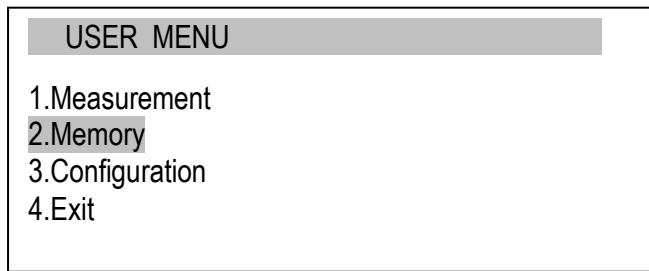

Move the cursor to *Memory* and press *ENTER*.

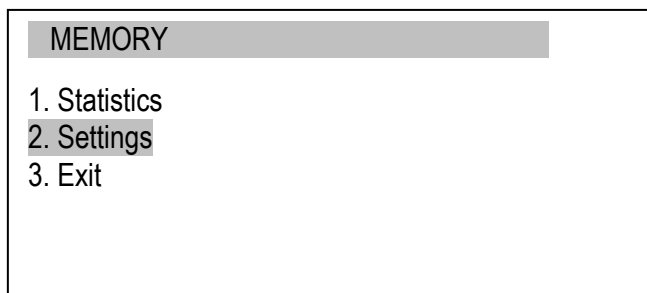

Move the cursor to *Settings* and press *ENTER*.

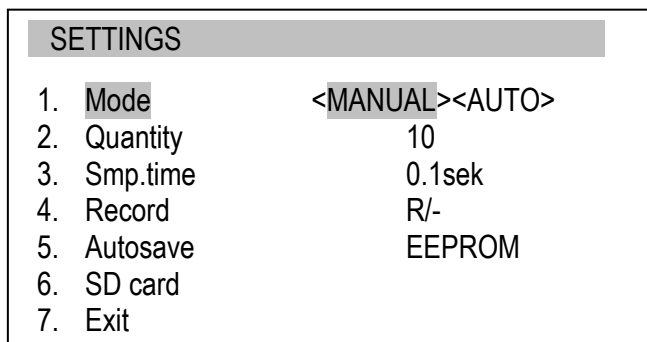

Setting the mode for collecting data:

- *MANUAL* – each time after *MEM* is pressed,

- *AUTO* – automatically at specified intervals.

Insert quantity of samples (max 100)

After choosing *Manual* mode user should specify whether he wants to save the time of each measurement (*R/D&T* option).

In *Autosave* option user can choose the place of autosaving results (*EEPROM* or *SDCARD*).

After selecting *AUTO*, enter the number of samples (max 100) and sampling time (0.1÷99.9 s. or 0,025÷25s depending on speed of measurement in *Configuration*).

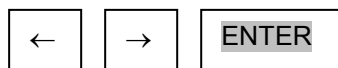

To start the collection of measurements, exit the menu and press *MEM* several times or press *MEM* for automatic save. When in the automatic save mode, press and hold *MEM* to go to the data save menu

13.2.2 Presentation of collected measurements (Statistics)

The *Statistics* option allows for the following forms of presentation of the collected data:

<PRINT> – transmission to a printer,

<HISTOGRAM> – bar graph,

<GRAPH> – graph with a time axis.

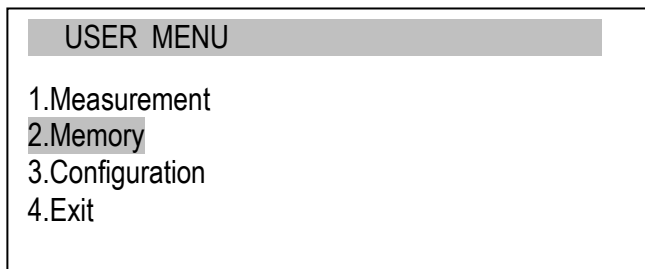

Move the cursor to *Memory* and press *ENTER*.

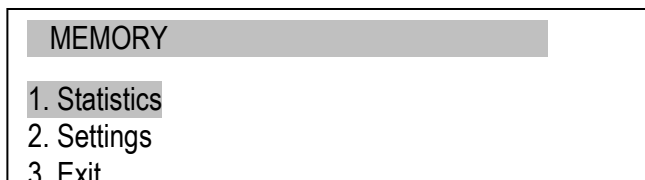

Move the cursor to *Statistics* and press *ENTER*.

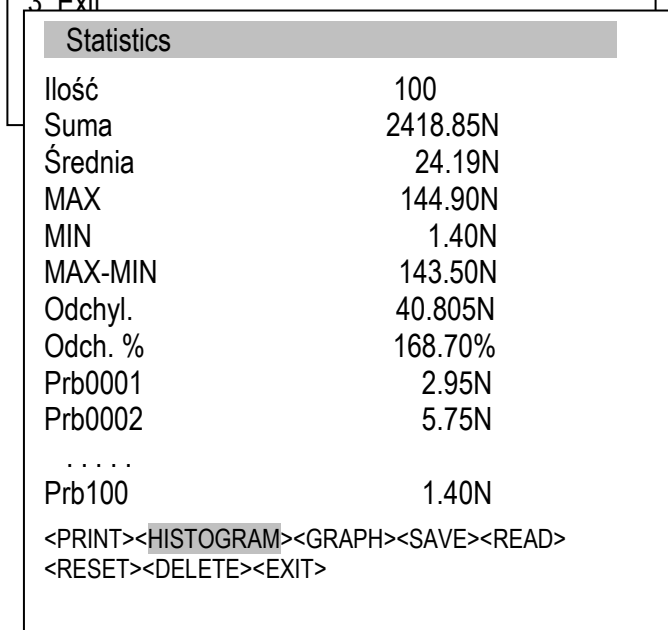

Select one of the options from the lower menu bar:

- *PRINT* – transmission to a printer,

- *HISTOGRAM* – bar graph,

- *GRAPH* – graph with a time axis.

...

- *RESET* – erases the entire memory,

- *DELETE* – deletes a selected memory file.

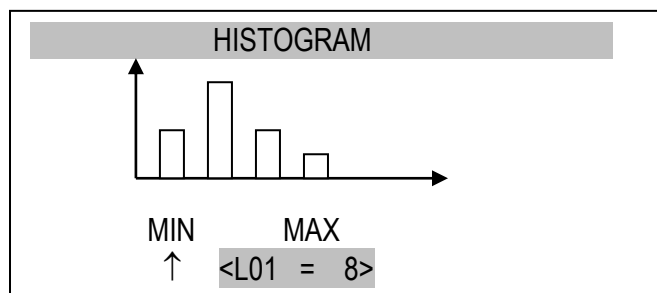

Indicators <L... =..> provide the size of the bar indicated by the ↑ arrow.

To move the arrow (scroll the graph), use the ← and → keys.

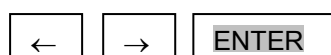

13.2.3 Save, read, erase memory (Statistics)

The *Statistics* option allows for the following:

- < *SAVE* > – saves the data currently presented,
- < *READ* > – reads a file from the memory,
- < *RESET* > – erases the data currently presented,
- < *DELETE* > – delete selected data file.

These options show up in the bottom bar (change option using ← or → keys).

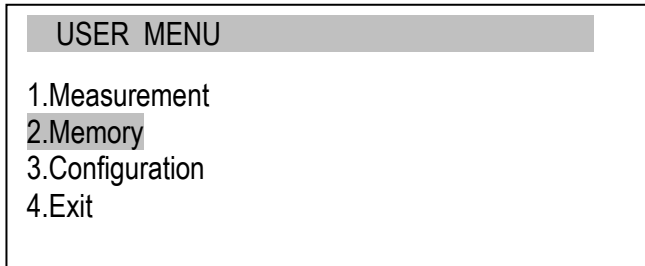

In order to choose saving location move the cursor to *Memory* and press *ENTER*.

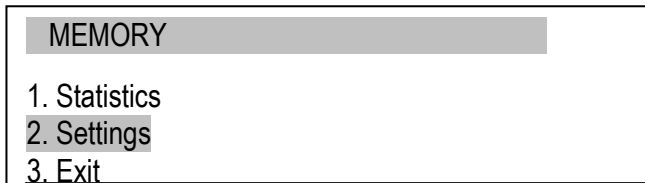

Move the cursor to *Settings* and press *ENTER*. Choose *Mode*. In *Auto* mode results are saved to RAM memory. In *Manual* mode saving to RAM, EEPROM or microSD card is possible.

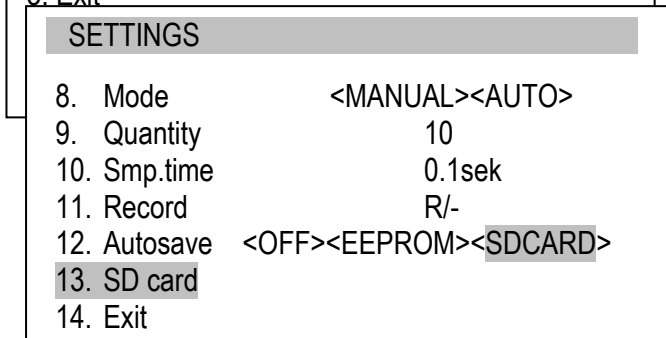

In order to save file on SD card set *Autosave* to *SDCARD* and move cursor to *SD card* position and press *ENTER*.



The following options will appear:

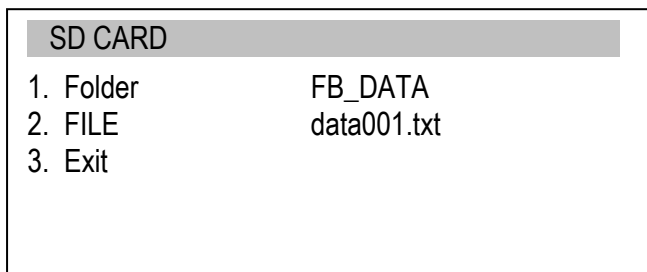

- *Folder* – enables to inscribe the name of the folder on microSD card,
- *FILE* – enables to inscribe file name on microSD card,
- *EXIT* – exit.



13.3 Configuration

This selection includes all options for setting the gauge's modes of operation.

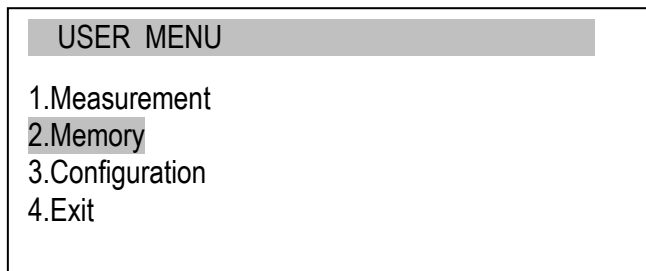

Move the cursor to *Configuration* and press *ENTER*.

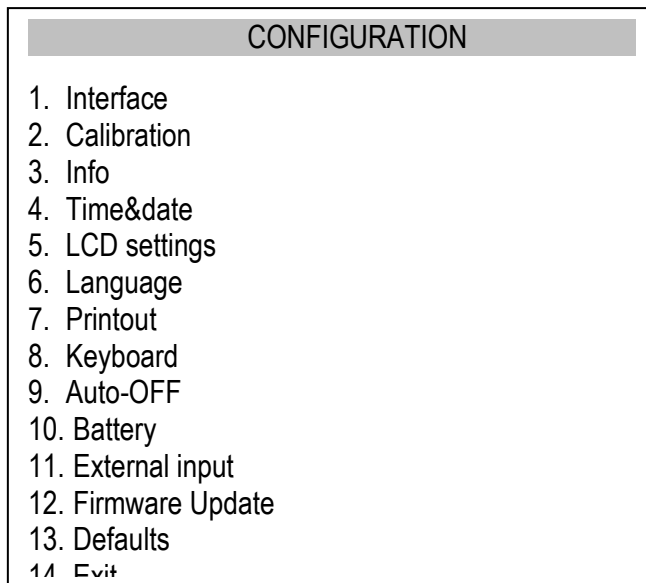

Move the cursor to the desired option and press *ENTER*.

ENTER

13.3.1 Setting serial ports

The parameters of the serial connector must be suitable for the device receiving the signal.

| |
|-----------------|
| USER MENU |
| 1.Measurement |
| 2.Memory |
| 3.Configuration |
| 4.Exit |

| |
|---------------|
| CONFIGURATION |
| 1.Interface |
| 2.Calibration |
| 3.Info |
| 4.Date/time |
| ... |

| |
|------------|
| INTERFACE |
| 1. RS-232C |
| 2. USB |
| 3. Exit |

| | |
|-------------|--------|
| INTERFACE | |
| 1. Baudrate | 4800 |
| 2. Bits | 8-bit |
| 3. Parity | none |
| 4. Sending | NORMAL |
| 5. Exit | |

| | |
|-------------|-------------------------------------|
| INTERFACE | |
| 1. Baudrate | 4800 |
| 2. Bits | 8-bit |
| 3. Parity | none |
| 4. Sending | <NORMAL><NO STB><AUTOSTB> <CONTIN.> |
| 5. Exit | |

Parameters to be set:

- *Baudrate* – transmission and receiving rate (4,800 ÷ 115,200 bps),
- *Bits* – number of bits which constitute a character (7 or 8 bits),
- *Parity* – control of parity (no control, even – confirmation of parity, or odd – confirmation of odd parity),
- *Sending* – transmission method during measurement:
 - *NORMAL* – after using the *PRINT* key, with stable result,
 - *NOSTB* – after using the *PRINT* key, irrespectively of the result stability,
 - *AUTOSTB* – automatically after the result has stabilised,
 - *REMOVE* – automatically after unload (under 10d or zero signalization threshold) previous stable result is send; if *PEAK* option is on, after unloading zeroing of indications is carried out,
 - *CONTIN.* – continuous transmission, approx. every 0.1 s.

| | | |
|---|---|-------|
| ← | → | ENTER |
|---|---|-------|

When the force meter is equipped with two serial interfaces (RS232C and USB) in submenu *Interface* two options are available *RS232C* and *USB*. After choosing proper port all settings are done the same way as above.

13.3.2 Force meter calibration

Entrance to calibration is secured by PIN password. Calibration should be executed by AXIS personnel.

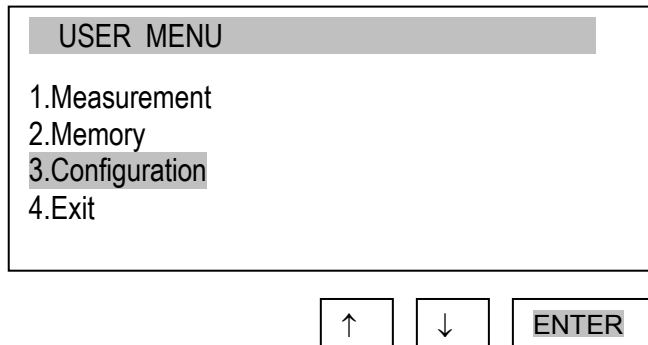

Reset the device without load using the $\rightarrow 0 \leftarrow$ key.

Use the navigation keys and *ENTER* to select *Configuration* and then *Calibration*.

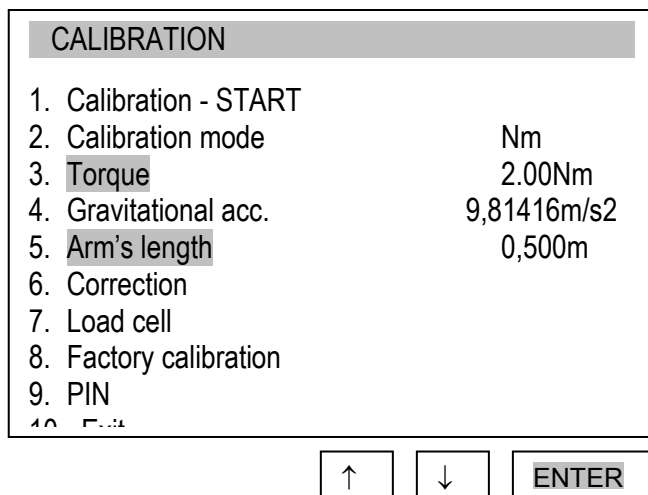

Depending on the arm choose *Torque* and *Arm's length* options.. The $\langle \dots \rangle$ option allows for entering any value.

Enter the gravitational acceleration to correctly convert mass (kg) into force (N).

If the exact “g” value is not known, enter the parameters of the geographical location (latitude and above mean sea level). The “g” value will be calculated automatically.

Apply the standard of mass to the gauge.

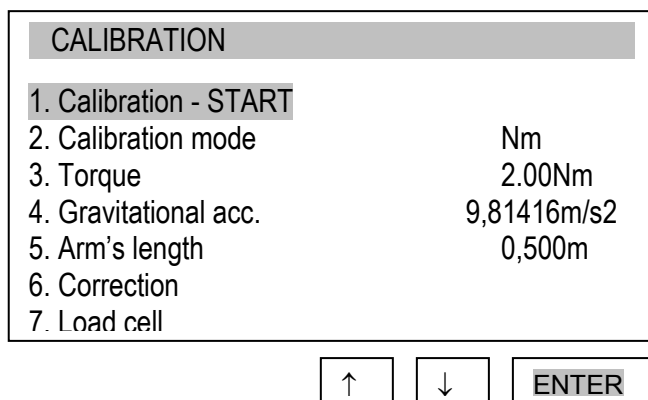

Use the navigation keys and *ENTER* to select *Calibration* and wait until the calibration process is completed.

Correction option enables changing torque indications with inscribed value.

Factory calibration option enables to return to factory settings.

13.3.3 Information

Option gives basic information about the device.

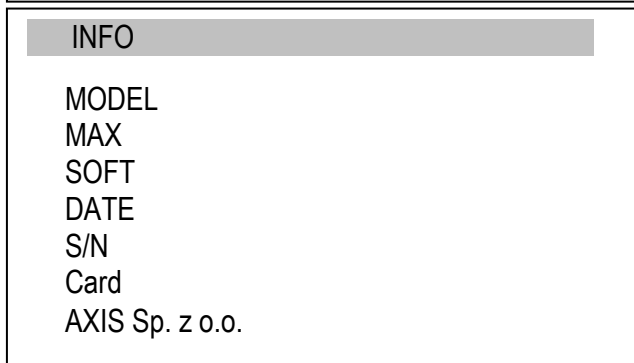
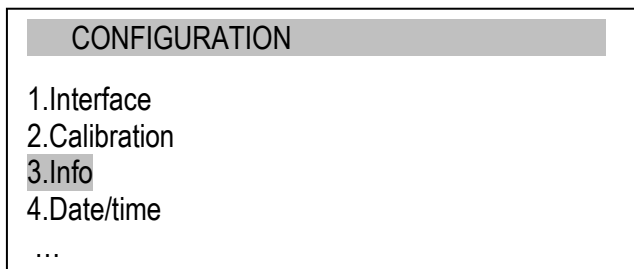
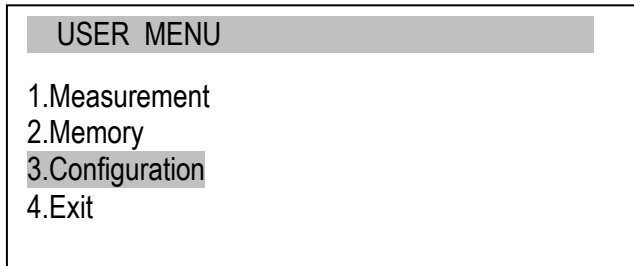

Available information:

- force meter type (*Model*)
- measurement range (*MAX*)
- internal software version (*SOFT*)
- serial number (*S/N*)
- production date (*DATE*)
- memory card type (*Card*)
- producer name

13.3.4 Setting date and time

This option is used for entering the current date and time. Access to this setting is secured by the PIN code.

| USER MENU | |
|-----------|---------------|
| 1. | Measurement |
| 2. | Memory |
| 3. | Configuration |
| 4. | Exit |

| CONFIGURATION | |
|---------------|-------------|
| 1. | Interface |
| 2. | Calibration |
| 3. | Info |
| 4. | Date/time |
| ... | |

| TIME&DATE | |
|-----------|--|
| 1. Time | 10:00:00 |
| 2. Date | 2011-01-11 |
| 3. PIN | 0 |
| 4. Format | <YYYY-MM-DD><MM- DD- YYYY> <DD-MM-YYYY> |
| 5. | Exit |



Use the navigation keys and *ENTER* to select *Date and time*. If a *PIN* has already been entered (other than 0), after selecting *Time* or *Date*, the cursor will move to the *PIN* option, where a correct 4-digit *PIN* has to be entered. To enter the correct digits, use the ↑, ↓, →, ← keys and *ENTER*.

To enter a new code (*NEW*), select the *PIN* option. When entering a new code, type in the same number twice (message: *REP.*).

The *FORMAT* option allows for the selection of the date format on print-outs.

13.3.5 LCD settings

This option adjusts the gauge’s display to external lighting conditions.

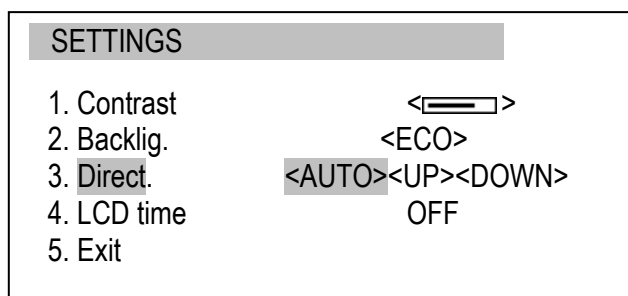
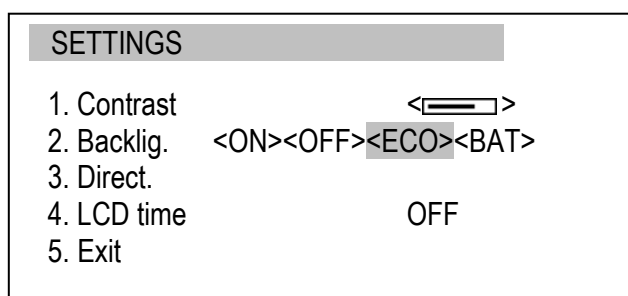
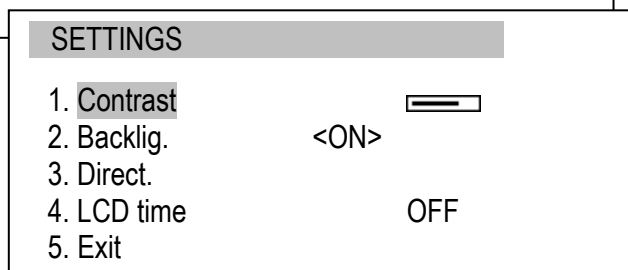
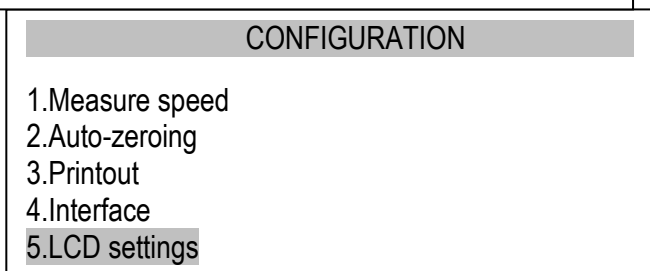
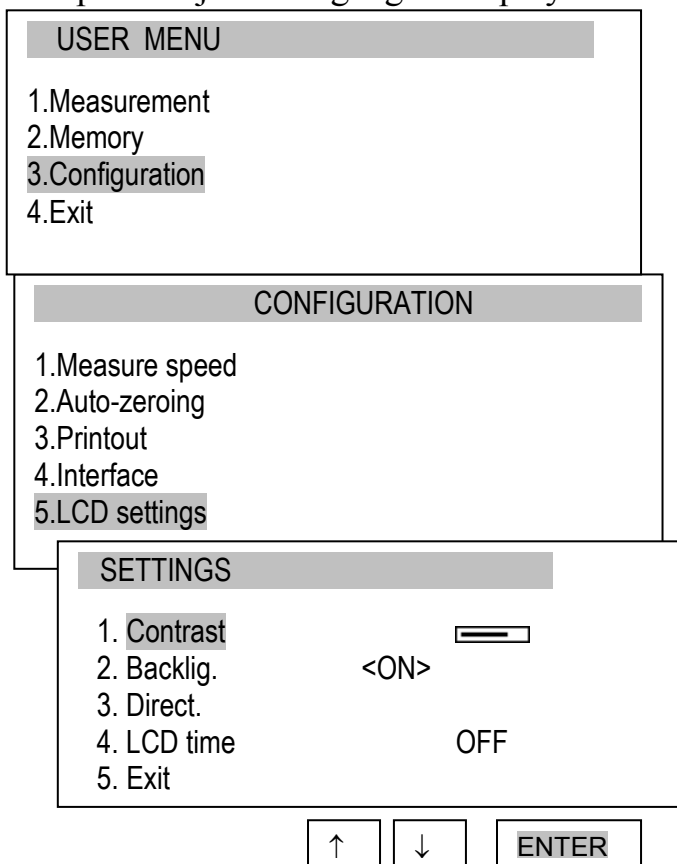

Use the navigation keys and *ENTER* to select *LCD settings*. Next, use *→*, *←* and *ENTER* to set the contrast at which the display is best legible.

When setting *Backlig.* (backlighting), select one of the following options:

- *OFF* – backlighting OFF,
- *ON* – backlighting continuously ON,
- *ECO* – to backlight, use the *BACKLIGHT* key,
- *BAT* – backlighting is turned off after 30 seconds to save the batteries.

The *DIRECT.* (direction) option is used for selecting the display’s direction:

- *AUTO* – automatic rotation of the displayed image,
- *UP* – standard direction,
- *DOWN* – inverted image.

The *LCD TIME* option displays the date and time during measurement in the display’s upper bar.

13.3.6 Selecting the menu language

Three menu languages are available:

- <PL> – Polish,
- <ENG> – English,
- <DE> – German,
- <ESP> - Spanish.

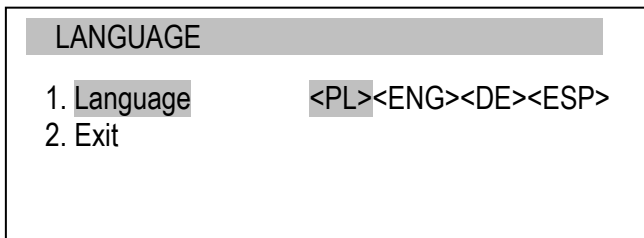
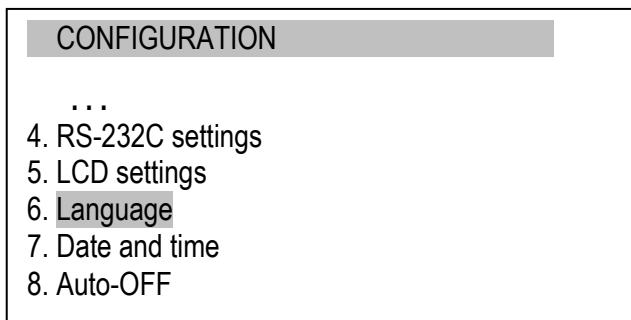
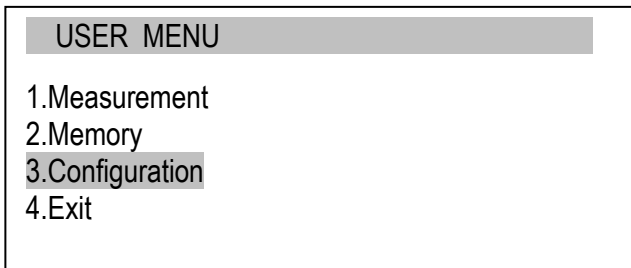

Use the navigation keys and *ENTER* to select *Language*. To select one of the available menu languages, use the →, ← keys and *ENTER*.

To enter a new code (*NEW*), select the *PIN* option. When entering a new code, type in the same number twice (message: *REP.*).

13.3.7 Printout settings

According to the requirements of GLP procedures, it is possible to use an external printer to produce print-outs from the gauge including text information.

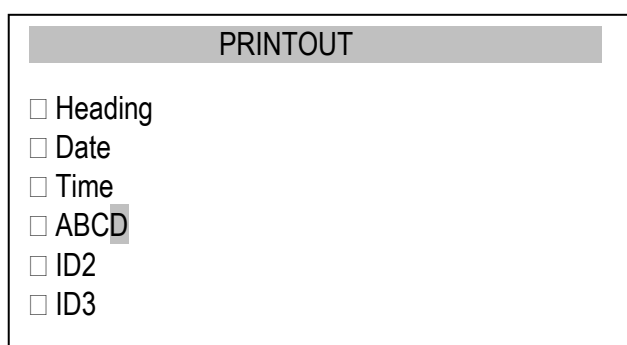
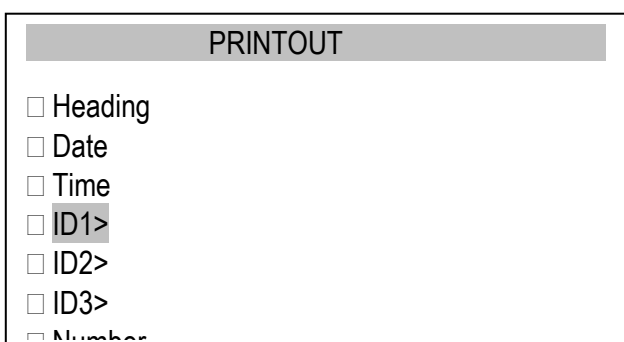
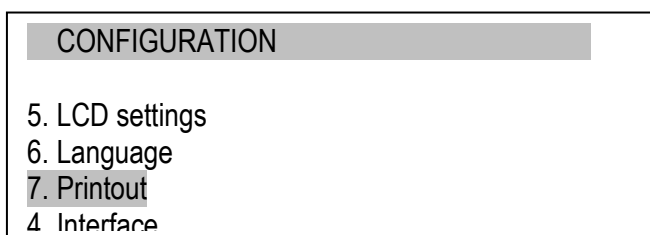
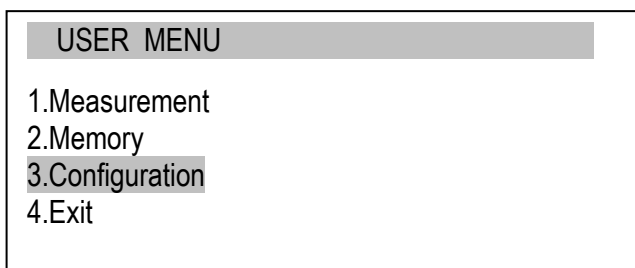

Use the navigation keys and *ENTER* to select *Printout* and the suitable print components.

ID1, ID2, ID2 – text strings (up to 20 characters) forming the lines of the print-out, entered using the gauge’s navigation keys (starting from →).

To enter the characters, select *ID* using *ENTER* and press →. The characters are entered using the navigation keys ↑ and ↓. To move the cursor to the consecutive positions, use ← and →. To confirm the entered string, press *ENTER*. To delete a character, enter space

13.3.8 Turning the sound ON/OFF when using the keypad (beep)

This options turns ON or OFF the sound signalling that a key on the keypad has been pressed. When the sound is turned on, the user usually does not apply excessive force when pushing the keys.

| USER MENU |
|-----------------|
| 1.Measurement |
| 2.Memory |
| 3.Configuration |
| 4.Exit |

| CONFIGURATION |
|-----------------|
| 3. Printout |
| 4. Interface |
| 5. LCD settings |
| 6. Language |
| 6. Time&date |
| 7. Keyboard |

| KEYBOARD | |
|----------|-----------|
| 1. BEEP | <ON><OFF> |
| 2. Exit | |

| | | |
|---|---|-------|
| ↑ | ↓ | ENTER |
|---|---|-------|

| KEYBOARD | |
|----------|------|
| 1. BEEP | <ON> |
| 2. Exit | |

| | | |
|---|---|-------|
| ← | → | ENTER |
|---|---|-------|

Use the navigation keys and *ENTER* to select *Keypad* and *Buzzer*, and one of the following options:

- *ON* – sound ON,
- *OFF* – sound OFF.

13.3.9 Automatic power OFF (Auto-OFF)

This option allows for an automatic cut-off of the gauge’s power supply to save the battery’s energy.

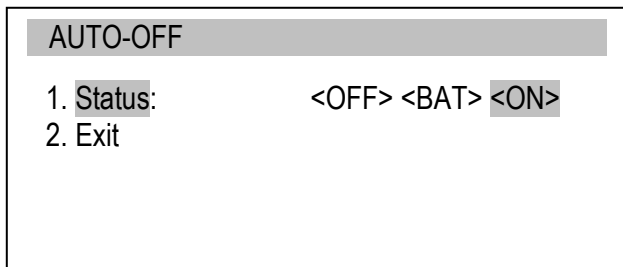
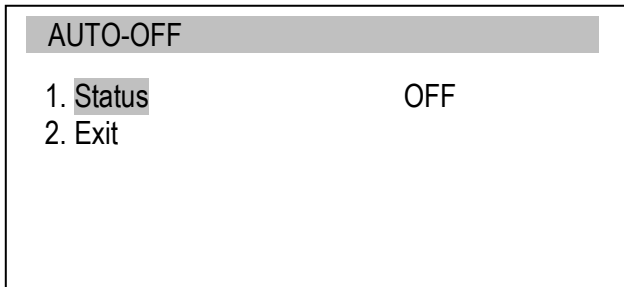
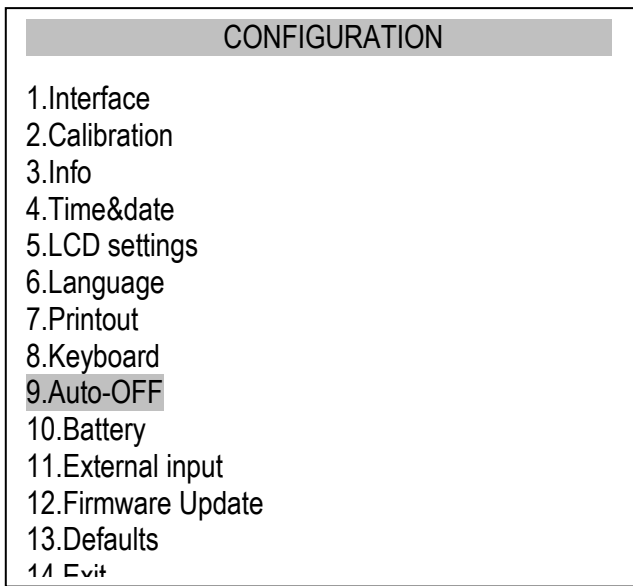
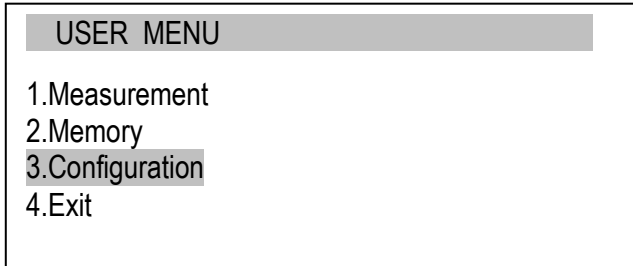

Use the navigation keys and *ENTER* to select *Auto-OFF* and *Status*, and one of the following options:

- *ON* – the power is turned off after 5 minutes, the indications remain unchanged,
- *BAT* – the power is turned off when the battery is low,
- *OFF* – the power is not turned off.

13.3.10 Monitoring the batteries' charge level (Battery)

This option is used for reading the charge level of the batteries and allows for the charging to be turned off to protect ordinary batteries, if such batteries are used instead of rechargeable batteries.



Charging ordinary batteries used instead of rechargeable batteries may lead to major damage to the gauge.

| USER MENU |
|-----------------|
| 1.Measurement |
| 2.Memory |
| 3.Configuration |
| 4.Exit |

| CONFIGURATION |
|-------------------|
| 1.Interface |
| 2.Calibration |
| 3.Info |
| 4.Time&date |
| 5.LCD settings |
| 6.Language |
| 7.Printout |
| 8.Keyboard |
| 9.Auto-OFF |
| 10.Battery |
| 11.External inout |

| BATTERY | |
|-------------|-----|
| 1. Charging | OFF |
| 2. Level | 80% |
| 3. Exit | |

| | | |
|---|---|-------|
| ↑ | ↓ | ENTER |
|---|---|-------|

| BATTERY | |
|-------------|------------|
| 1. Charging | <OFF> <ON> |
| 2. Level | 80% |
| 3. Exit | |

| | | |
|---|---|-------|
| ← | → | ENTER |
|---|---|-------|

Use the navigation keys and *ENTER* to select *Battery* and *Charging*, and one of the following options:

- *ON* – charging ON,
- *OFF* – charging OFF.

13.3.11 External input

This option can be used when force gauge is applied in any kind of automated process. THRESHOLD (optionally) output is used for this function so when using this option threshold function should be turned off.

| | |
|-----------------|--|
| USER MENU | |
| 1.Measurement | |
| 2.Memory | |
| 3.Configuration | |
| 4.Exit | |

| | |
|--------------------|--|
| CONFIGURATION | |
| ... | |
| 8. Keyboard | |
| 9. Auto-OFF | |
| 10. Battery | |
| 11. External input | |

| | |
|----------------|----------------------|
| EXTERNAL INPUT | |
| 1. Status : | <OFF><TRIGGER><GATE> |
| 2. Exit | |

Using navigation keys and *ENTER* key choose *Configuration* option and then *External input*. Choose *Status* option and using ← and → keys choose from:

- *OFF* – function off,

- *TRIGGER*:

a) manual measurement mode – measurement storing initiated by a single external signal,

b) automatic measurement mode – storing of set quantity of measurements initiated by a single external signal,

- *GATE*:

a) manual measurement mode - measurement storing initiated by a single external signal while *MEM* key is pressed,

b) automatic measurement mode – storing of set quantity of measurements initiated by external signal state time window.

13.3.12 Firmware update

Option designated for service

Option enables program update by connecting force gauge to computer using RS232 or USB interface. *Firmware update* message on force gauge's display is connected with this option. To delete this message, disconnect the force gauge from supply.

13.3.13 Defaults

This option restores factory settings (default settings) for all options.

The diagram illustrates the menu structure for restoring factory settings. It consists of three overlapping menu screens and three navigation buttons at the bottom.

- USER MENU:** A screen with a grey header 'USER MENU' and a list of options: 1.Measurement, 2.Memory, 3.Configuration (highlighted), and 4.Exit.
- CONFIGURATION:** A screen with a grey header 'CONFIGURATION' and a list of options: ... (three dots), 7. Date and time, 8. Auto-OFF, 9. Battery, and 10. Defaults (highlighted).
- DEFAULTS:** A screen with a grey header 'DEFAULTS' and the text 'Restore default settings?'. Below this text are two options: 'NO' and 'YES' (highlighted).

At the bottom of the diagram are three buttons: an up arrow (↑), a down arrow (↓), and a button labeled 'ENTER'.

Use the navigation keys and *ENTER* to select *Reset settings* and the option *YES*.

As a result of restoring factory settings, the gauge will reset and start continuous measurement.

14. Maintenance, troubleshooting and repairing minor types of damage

1. Keep the gauge clean.
2. When using the force gauge, make sure that no contamination gets between the gauge plunger and the enclosure. Upon identifying any contamination, remove it using a tool which does not conduct electricity.
3. Unauthorised person may not perform any repairs.
4. Have the gauge repaired by your local servicing facility. A list of servicing facilities is enclosed in the warranty.

Messages and faults:

| Message/fault | Cause | Recommendation |
|---|---|--|
| The message RESETTING is displayed for an extended period of time. | Resetting process disturbed | Keep the gauge in motionless position and press $\rightarrow T(0) \leftarrow$ |
| Message: AD range exceeded (+/-) | Resetting process disturbed | Put the gauge in horizontal position and turn it off and on using the <i>ON/OFF</i> key. |
| The values indicated by the gauge diverge significantly from correct values | Gauge out of adjustment | Contact a servicing facility to calibrate the gauge |
| Units displayed are different from the selected units | <i>UNIT/CLEAR</i> key pressed by accident | Press the <i>UNIT/CLEAR</i> key several times to display the correct units |

15. FSC menu diagram

Menu

