

# //AXIS



## ME-01 METER

Engineering documentation

FILE: 2016-04-19 DTR-ME-01-146 bC0109 GB

## Content:

1.	General information.....	3
2.	Completeness .....	5
3.	Technical data.....	6
4.	Assembly.....	7
5.	Keys and indicators.....	8
6.	Security rules .....	10
7.	Rules proceeding with used up scales.....	10
8.	Assembly and connecting external devices.....	11
9.	Meter external outputs .....	13
	9.1 Transmitter connection .....	15
	9.2 External key connection .....	16
	9.3 4-20m connection.....	17
	9.4 Connecting a computer, printer or label printer.....	18
	9.5 Detailed LonG protocol description.....	19
	9.6 Detailed EPL protocol description.....	21
10.	Accumulator change in aluminium meters .....	22
11.	General rules of using scale.....	23
12.	Balance checking and adjustment.....	24
13.	Start-up.....	25
14.	Weighing with tare.....	26
15.	Scale menu.....	27
16.	Menu navigation rules .....	28
17.	Scale setup (SEtUP).....	33
	17.1 Scale calibration (CALib).....	35
	17.2 Autozeroing function (AutoZEr).....	36
	17.3 Weight unit selection (Unit) .....	37
	17.4 Serial port parameters setting (SErIAL) .....	38
	17.5 Printout configuration (Print) .....	39
	17.6 Setting backlight function (b_LIGHt).....	41
	17.7 Analog out configuration (AnALoG).....	42
	17.8 Entering reference zero value (ZEro) .....	43
18.	Special functions description.....	44
	18.1 Products and users database (Prod i USEr) .....	45
	18.2 Pieces counting function (PCS).....	49
	18.3 Percentage weighing function (PERC).....	50
	18.4 Label choosing function (LABEL) .....	51
	18.5 Weighing animals function (LOC).....	52
	18.6 Maximum value indication function (UP).....	53
	18.7 Force measuring function (nEWton).....	54
	18.8 Total weight function (totAL).....	55
	18.9 Checkweighing function (thr).....	57
	18.10 Setting date and time function (dAtE).....	60
	18.11 Radio communication channel choice function (rF CHn) .....	61
	18.12 Charging accumulators function (bAttErY)- option.....	62
	18.13 Automatic switching off the scale function (AutoOFF) .....	63
	18.14 Statistical calculations function (StAt) .....	64
	18.15 Paperweight calculation (PAP).....	67
19.	Troubleshooting and maintenance .....	68
	Declaration of Conformity CE.....	69

## 1. General information

The ME-01 meter is ready subassembly, designed for single- or double-range balances, using the extensometer force sensors.

Meter versions:



### ***ME-01/A/18 (LED)***

- housing made of painted aluminum,
- LED18mm display,



### ***ME-01/A/LCD***

- housing made of painted aluminum,
- LCD18mm display,

***ME-01/N/18 (LED)***

- housing made of stainless steel,
- LED18mm display,

***ME-01/N/LCD***

- housing made of stainless steel,
- LCD18mm display,

***ME-01/N/25 (LED)***

- housing made of stainless steel,
- wyświetlacz LED25mm,

---

As a standard ME-01 meter is a subassembly of platform and overrun balances produced by AXIS.

Each meter has the set of special functions: automatic zeroing, pieces counting, comparing with threshold values, etc., which may be available for the user or not – according to the order.

In the further manual part the ME-01 meter operation is described, as the part of complete balance.

## **2. Completeness**

A standard set consists of:

1. ME-01 meter
2. Ferrit TN/20/10/7-3C90– 1 pcs.
3. Engineering documentation

### 3. Technical data

Parameter	ME-01/A	ME-01/N	ME-01/N/25
Destination	to III class scales one and two-ranged with verification units number $n \leq 6000$		
Max verification units number	6000		
Internal resolution	1:16 777 216		
Power supply	AC: 230V 50Hz DC: 12V or accumulator 6V ÷ 12 V		AC: 230V 50Hz DC: 12V
Keyboard	Function buttons ( from 5 to 128 pcs.) Or touch panel (touchpad)		
Display	LED, LCD (alphanumeric or graphical)		
Transducer supply voltage	DC: 5V or 5V keying (choper)		
Voltage measurement range	-10 mV ÷ 10 mV or 0 mV ÷ 10 mV		
Maximal voltage signal for stable loading	+ 10 mV		
Minimal voltage signal for stable loading	- 10 mV or 0 mV		
Minimal allowable input signal corresponding to verification unit e	0,3 µV		
Sensor impedance range	40÷4000 Ω		
Work temperature range	- 10 °C ÷ +40 °C		
Part of limiting error	0,5		
Sensor connecting	4 or 6 conductor system		
Maximal cable length	75 m/mm <sup>2</sup>		
Primary measurement module functions	<ul style="list-style-type: none"> <li>- gross and net mass indication</li> <li>- automatic and semi-automatic zeroing</li> <li>- semi-automatic tare,</li> <li>- connection with computer (RS232C, RS485, Ethernet, USB, radio)</li> <li>- analogue output</li> <li>- technological process steering</li> <li>- and others</li> </ul>		
Enclosure type	OSA	OSN	ODN
Security level	IP40	IP65	
Dimensions	190x140x70mm	200x146x77mm	238x182x77mm
Weight	1,8kg	2,3kg	2,3kg

The metrological parameters of the balance are indicated on the rating plate.

### 4. Assembly

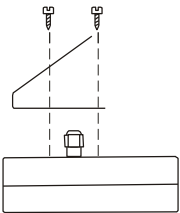
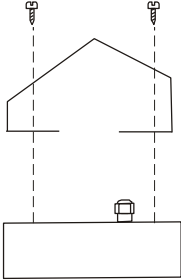
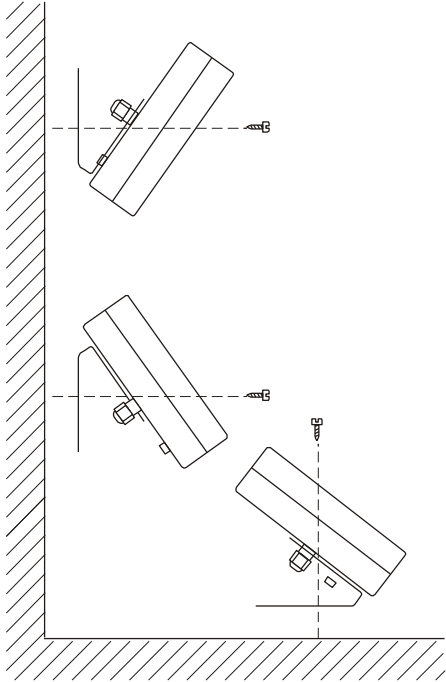
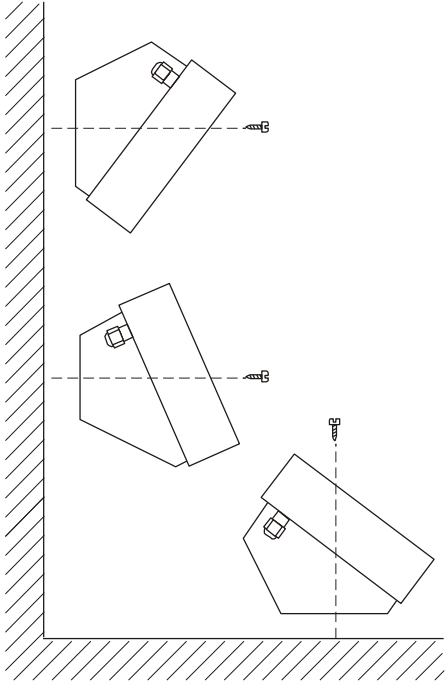
Assembly	ME-01/A	ME-01/N	ME-01/N/25
Meter grip assembly			
3 ways to mount the meter to wall			
Mounting to wall or desktop	2 holes $\Phi 5$ , spacing 59mm	2 holes $\Phi 5$ , spacing 160mm	2 holes $\Phi 5$ , spacing 203mm

## 5. Keys and indicators

LCD display version:

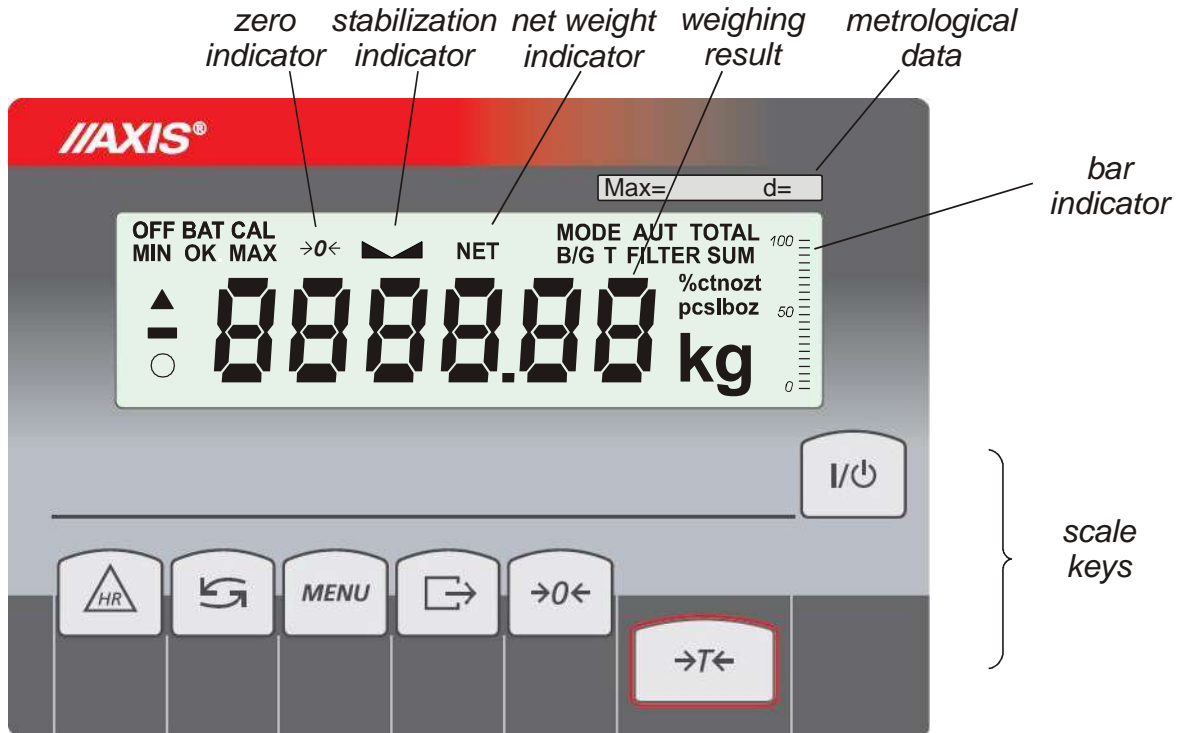

Keys:	I/O	- switch-on / switch-off (standby),
"	→T←	- tare, menu position confirmation, next digit (when inscribing),
"	→0←	- zeroing, scrolling menu, increasing digit (when inscribing),
"	↵	- result printout, decimal point (when inscribing),
"	MENU	- menu,
"	↻	- function switch: special function/weighing,
"	HR	- temporary high resolution indication,
Indicators:	→0←	- zero indicator (unloaded scale),
"	∩	- result stabilization indicator,
"	NET	- net weight (after using →T← key),
"	MODE	- special function menu turning on indicator
"	B/G	- gross weight (after using TARE and ↻ key)
"	AUT	- autotare function on,
"	T	- tare memory function on,
"	TOTAL, FILTER, SUM	- special functions indicators,
"	%, ct, n, g/m <sup>2</sup> , lb,mg	- unit indicators,
"	pcs	- pieces counting indicator,
"	n	- measurements quantity indicator (total function),
"	OFF	- scale turned off I/O (standby)
"	MIN	- weighing result under threshold I (thr function),
"	OK	- weighing result between threshold I and II,
"	MAX	- weighing result above threshold II,
"	BAT	- battery discharge indicator,
"	Δ, O	- ACtIV function indicator,
bar	indicator	- scale load indicator (0-100%)



**LED display version:**



klawisz	I/⏻	- switch-on / switch-off (standby),
"	→T←	- tare, menu position confirmation, next digit (when inscribing),
"	→0←	- zeroing, scrolling menu, increasing digit (when inscribing),
"	↔	- result printout, decimal point (when inscribing),
"	MENU	- menu,
"	↻	- function switch: special function/weighing,
"	HR	- temporary high resolution indication,
wskaźnik	→0←	- zero indicator (unloaded scale),
"	△	- result stabilization indicator,
"	NET	- net weight (after using →T← key),
"	W1	- first range on in two-range scale,
"	W2	- second range on in two-range scale,
"	HOLD	- indication „locked” (concerns LOC and UP functions),
"	FUNC	- special function turned on,
"	PCS	- pieces counting,
"	g, kg, lb, unit	- weight unit (g-gram, kg-kilogram, lb-pound, unit – other),
"	MIN	- weighing result under threshold I (thr function),
"	OK	- weighing result between threshold I and II,
"	MAX	- weighing result above threshold II,

During inscribing numerical values needed during using special functions keys have special functions.

## 6. Security rules

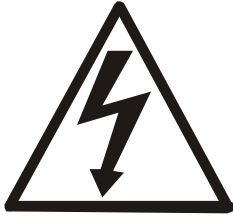

To avoid electrical shock, scale or other connected peripheral devices damage, it is necessary to follow the security rules below.

- To supply the scale use power outlet with protective contact (not for scales with external feeder).
- Repairs and essential scale regulations can be made only by authorized personnel.
- To avoid fire risk use a feeder of an appropriate type (supplied with a scale). Pay attention that supply voltage is compatible with specified technical data.
- Do not use a scale when its cover is opened.
- Do not use a scale in explosive conditions.
- Do not use a scale in high humidity.
- If a scale seems not to operate properly, plug it out of the mains and do not use it until checked by authorized service.

## 7. Rules proceeding with used up scales



According to obligatory rules concerning environment protection used electronic devices should not be put in a container with normal waste.

- After exploitation used scale should be given to special units authorized to collect used electronic equipment or to the place where the device was bought.

## 8. Assembly and connecting external devices

1. To build a scale basing on ME-01 indicator contact authorized manufacturer service point or use Installation Guide delivered with the indicator (other brochure).
2. The manufacturer gives a full guaranty for ME-01 indicator only when the indicator was mounted by AXIS Sp. z o.o. In other cases the guaranty obligation is taken over by the final contractor of the weighing device.



**Before connecting the sensors to the indicator unplug the device from the mains to avoid damaging the indicator.**

To comply CE marking requirements, for connecting the wires use filtering core  $\phi 20\text{mm}$ .

The core should be placed within 30mm from the place of its connection.

Single strain gauge scheme inside ME-01:

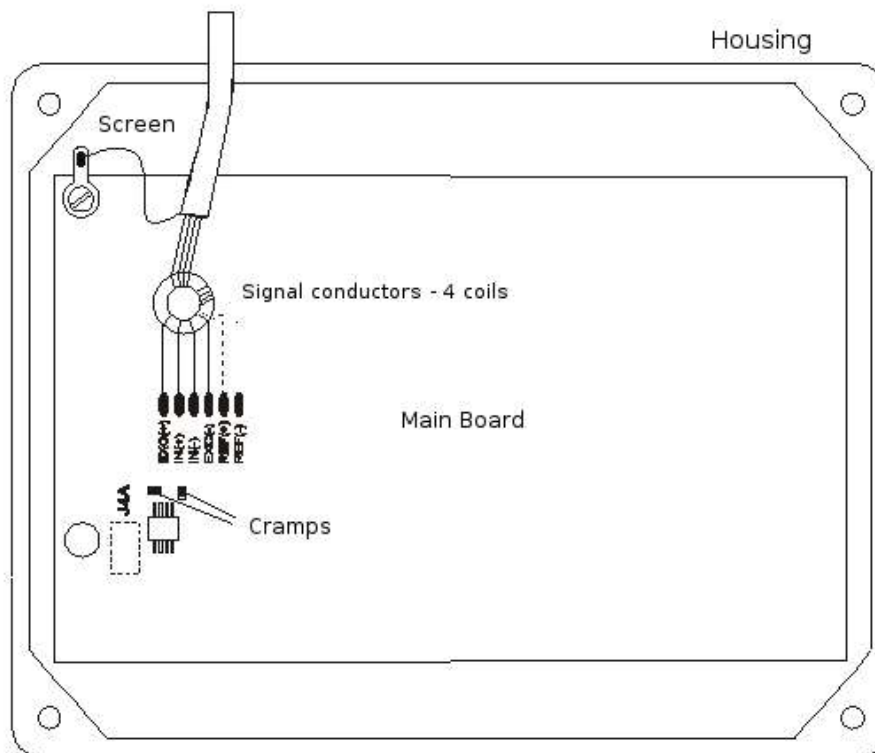

When 6-wires connection of strain gauge transducers is used (REF+ and REF-) jumpers shown on the picture above should be soldered out from the main board (load cell wires are connected EXC+, EXC-, IN+, IN- and additionally REF+ and REF-).

Commonly used wire colors:

EXC+ red

EXC- black  
IN+ green  
IN- white  
REF+ brown  
REF- yellow

3. Connect the external devices cables to the meter sockets.



**All devices should be powered from the same line (phase) 230V.**

Diagram of common wires and shields in the platform balances:

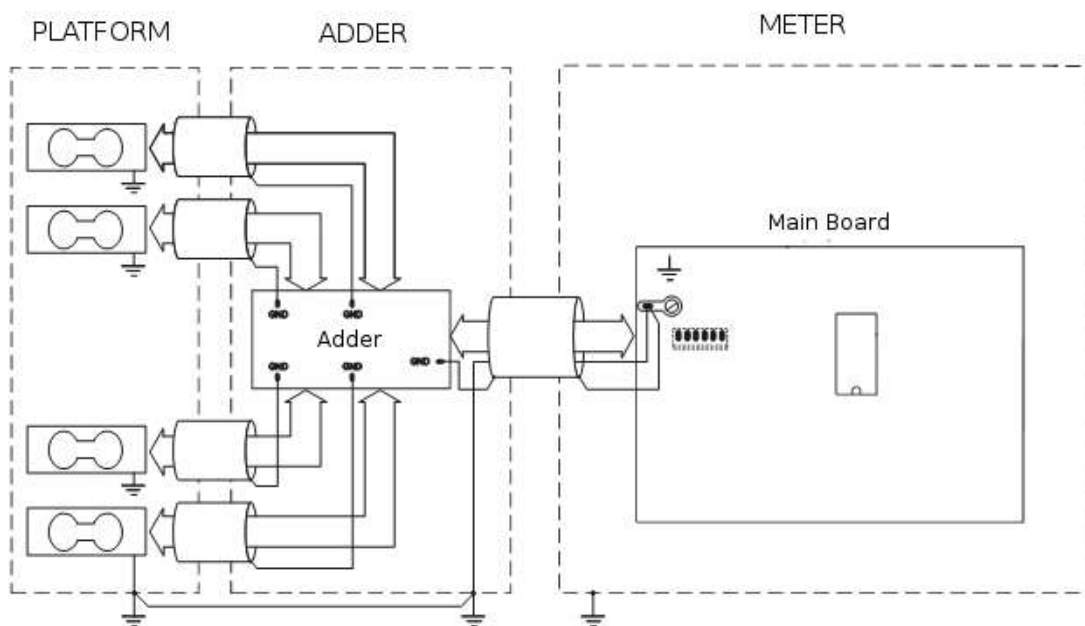

**Caution:** The galvanic connection of sensors and adder housing is necessary.

## 9. Meter external outputs

**ME-01 meter in aluminium housing:**

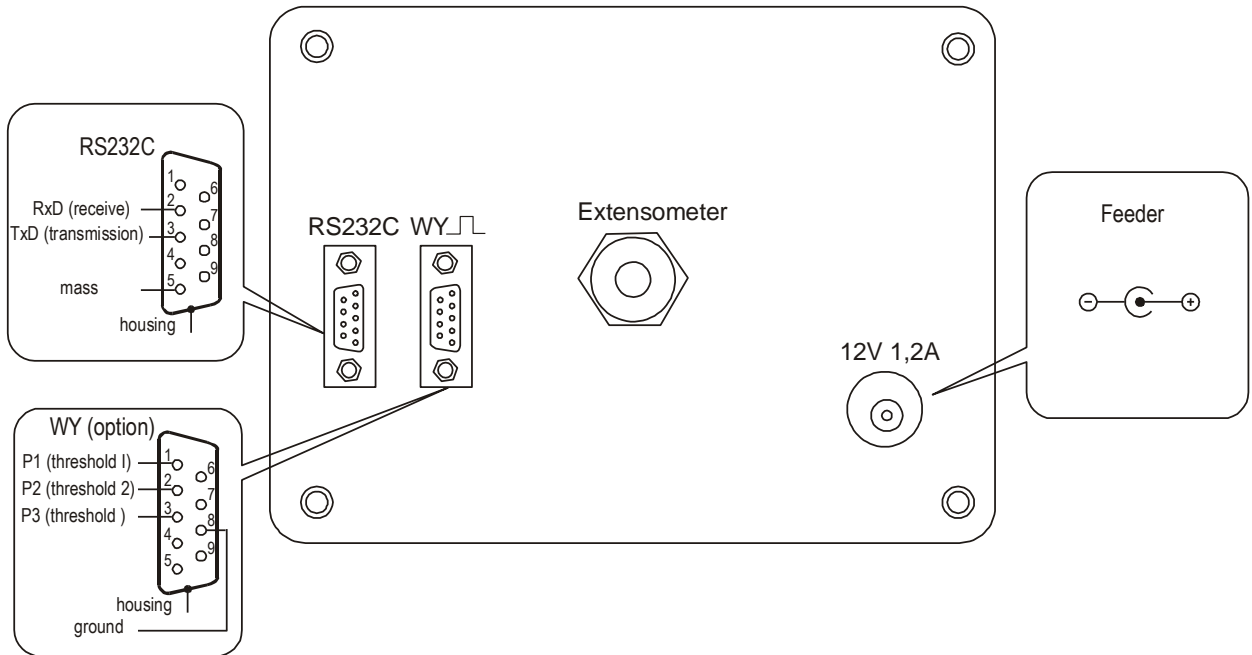

**ME-01 meter in stainless steel housing:**

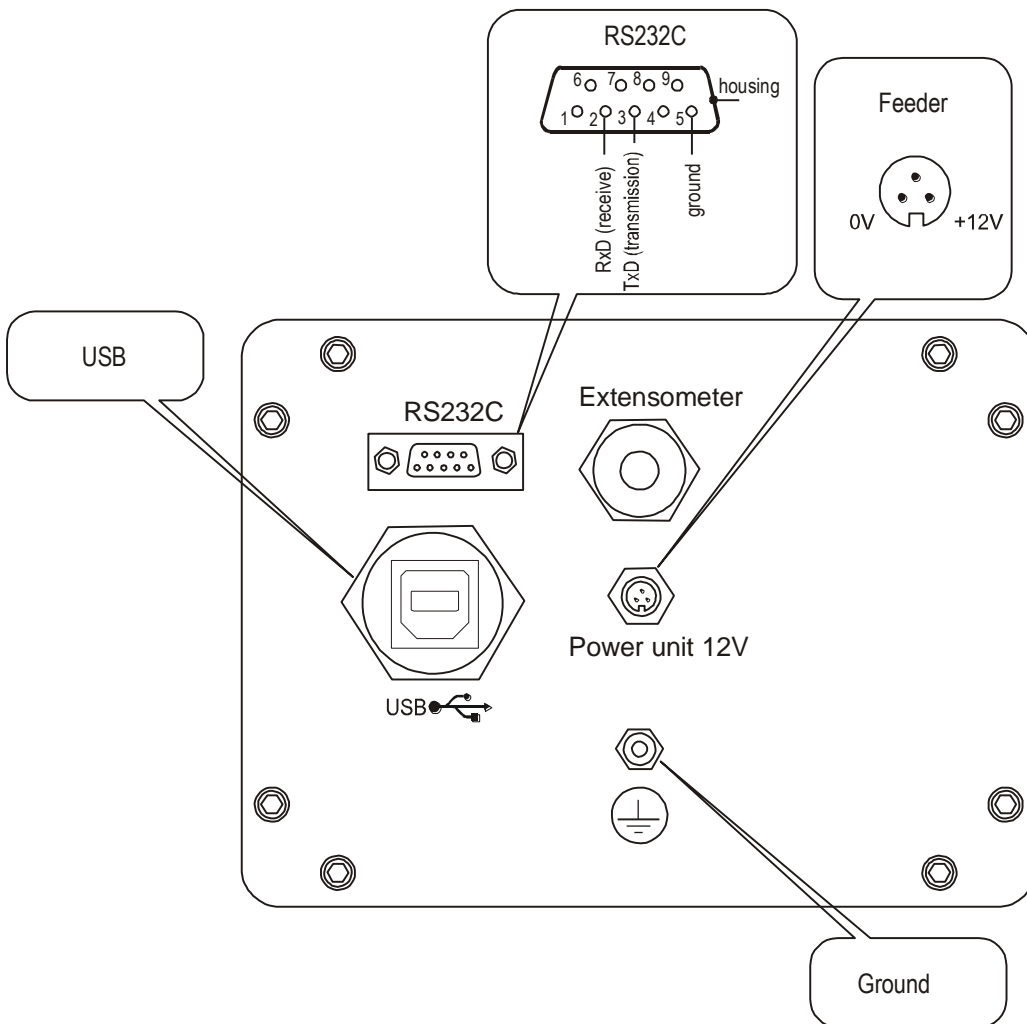

Separate ground connection (scales in stainless steel version) must be connected using additional conductor.

Extensometers are connected permanently.

**9.1 Transmitter connection**

P1-P3 (THRESHOLDS) outputs are used to connect dosing or signalling (option) devices. There are opto-isolators of an open collector type with 100mA / 24V maximum load. They can be connected directly to transmitters inputs or to MS3K/P board offered by AXIS separately or in ST 3K/P control box (3 transmitters, own power supply).

In ME-01/A connection THRESHOLD is placed on indicator's housing. In ME-01/N meter connection is placed on conductor.

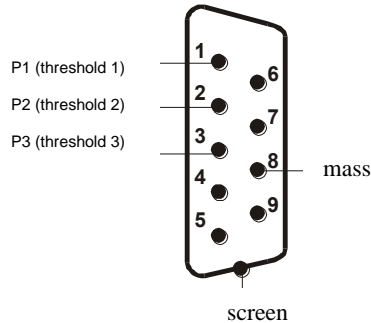

Optional indicators outer wires have digital markers.

Marker No.	Signal	Wire color*
1	P1 (I threshold)	Green
2	P2 (II threshold)	White
3	P3 (zero)	brown
10	GND (indicator ground)	black or yellow

\* colors might change

Diagram for direct connect a transmitter to THRESHOLD output:

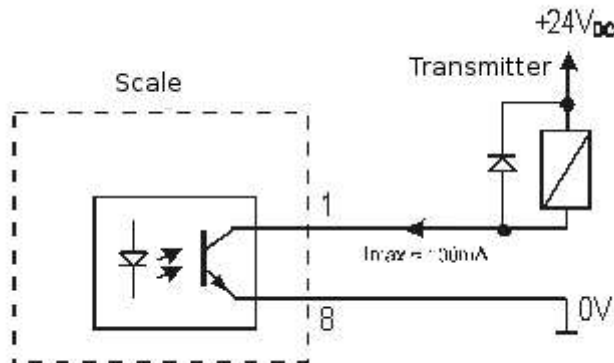

\* in option without an interface – 10 is in the place of 8

Outputs are adapted for direct connection RM96P transmitter of DC24V input voltage and AC250V 8A output. Transmitter's coil has to be secured with diode e.g. 1N4148.

It is recommended to use MS 3K/P electronic board (3 transmitters of RM96P type – max. load of 3A/250V) or complete ST 3K/P control box (feeder, 3 transmitters like above).

The way THRESHOLD outputs work is described in the separate document (*Special functions description*).

## 9.2 External key connection

The input of external keys allows to place (make double) selected scale keys into control box or operator's workstation. As a standard the input is taken out with a wire for direct connect to a control panel. ME-01 indicators can be equipped with external key interfaces (as an option on demand).

Marker numbers and outer wires colors indicators:

Marker No.	External keys inputs	Wire color*
12		Yellow
13	MENU	Brown
15	→0←	Green
18	→T←	White
20	+24V	Pink
21	I/ϕ	Blue
22	HR	Red
23	B/G	violet

\* colors might change

External key connecting is shown below. It is crucial to use external supply (24V) in order to make current flow through scale transoptor input. This way of connection provides galvanic separation of the scale from automatics system which increases resistance to external interference and increases reliability.



External keys connecting:

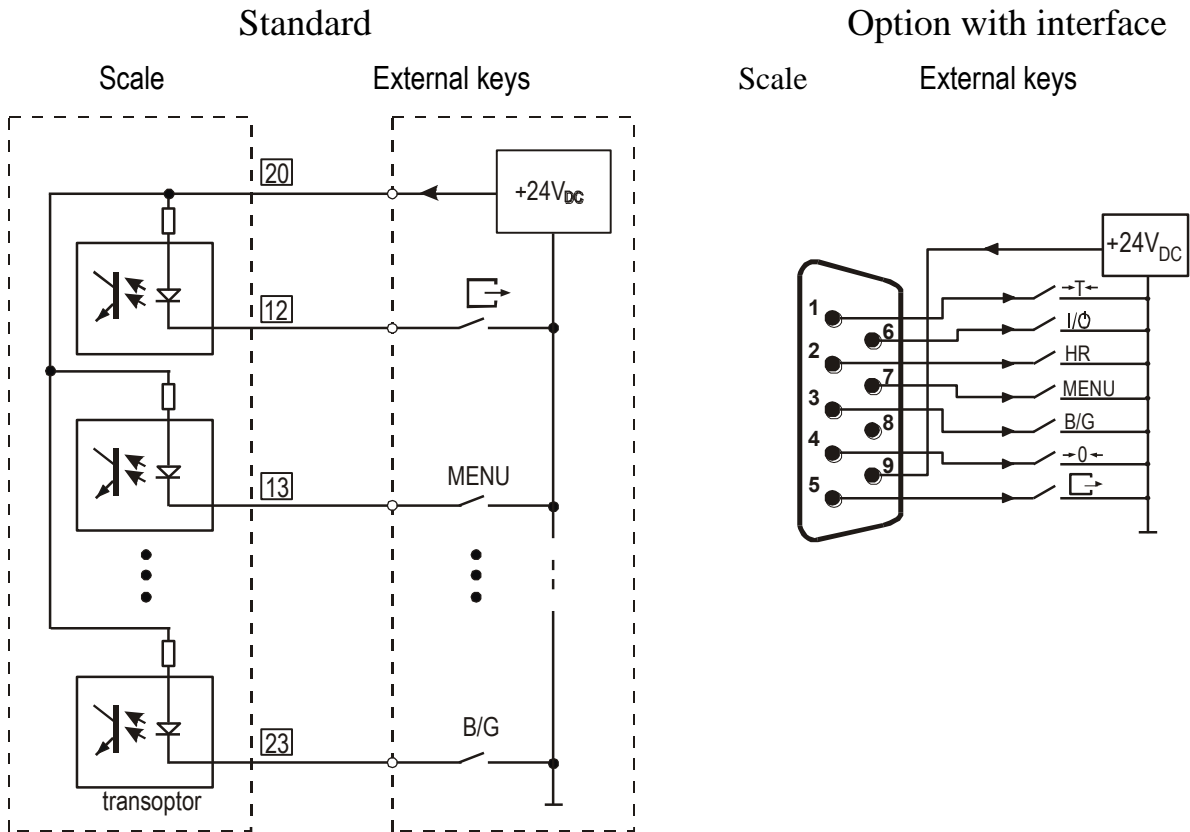

9.3 4-20m connection

Way of connecting analogue output 4-20mA (0-20mA, 0-10V):

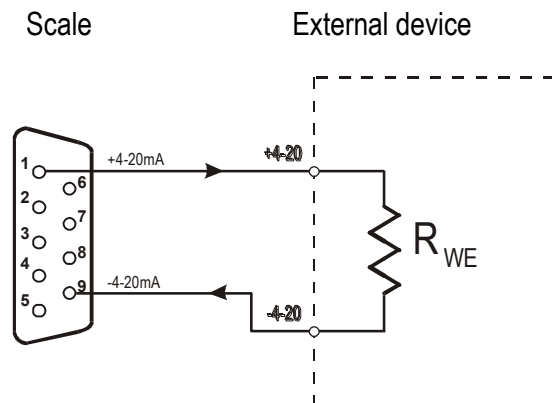

**Attention:**  $R_{we} < 510\Omega$

## 9.4 Connecting a computer, printer or label printer

The scale is equipped with RS232C, which can be used to connect external devices such as computer or a printer.

When cooperating with computer, the scale sends weighing result after initialize signal from computer or after pressing  key on the scale.

When cooperating with a printer data is send automatically after result stabilisation, but next transmission is possible after removing previously weighted sample.

When cooperating with label printer after pressing  key, the scale sends instructions set for the label printer. Label number 0001, hour, data (if the clock is installed and on) and nett weight. During transmission *LabEL* communicate is displayed.

The way of sending data and transmission parameters is set using *SERIAL* special function.

Set of send data is set using special function *Print*.

The following data can be send:

- Header (scale type, Max, d, e, serial number),
- Operator identification number,
- Successive printout number (measurement),
- Identification number or product bar code,
- Number of pcs (PCS function only),
- Single detail mass (PCS function only),
- Nett weight,
- Tare (package mass),
- Gross weight,
- Total mass (Total function only).

If the scale is equipped with two serial joints *Print* function is set independently for both interfaces.

Computer must have a special program for cooperation with data from a scale.

Dedicated programs are also offered by AXIS.

Except RS232C joint, the scale can be equipped with USB or Wi-Fi interface.

Needed controllers and instruction can be found on a CD supplied with Axis scales.

## 9.5 Detailed LonG protocol description

Standard communication parameters: 8 bits, 1 stop bit, no parity, baud rate 9600bps,

After using  key, measurement data is send together with text description (NET, TARE, GROSS) – all set by using *Print* option. If *Print* isn't set then only scale indication is send (as below).

Data exchange (communication):

- Readout of scale indication

Computer→Scale: **S I** CR LF (53h 49h 0Dh 0Ah),

Scale→Computer: scale response according to description below (16 bytes):

Byte	1	- sign „-“ or space
Byte	2	- space
Byte	3÷4	- digit or space
Byte	5÷9	- digit, decimal point or space
Byte	10	- digit
Byte	11	- space
Byte	12	- k, l, c, p or space
Byte	13	- g, b, t, c or %
Byte	14	- space
Byte	15	- CR
Byte	16	- LF

### **Attention:**

Network number different than zero (*SErIAL / nr* function) changes scale working mode: communication with a computer is possible after logging the scale in with 02h scale number command. To log the scale out use 03h command.

For example: Using a program to test RS232 interface ( program is available in [www.axis.pl / programy komputerowe](http://www.axis.pl / programy komputerowe) ) for scale number 1 please write: \$0201 to log in, then SI, and write: \$03 to close communication.

- Asking about scale presence in system (testing scale connection with computer):  
Computer→Scale: S J CR LF (53h 4Ah 0Dh 0Ah),  
Scale→Computer: M J CR LF (4Dh 4Ah 0Dh 0Ah),
- Displaying a inscription on scale's display (text communicate from computer):  
Computer→Scale: S N n n X X X X X X CR LF, nn-displaying time in seconds; XXXXXX-6 signs to display  
Scale→Computer: M N CR LF (4Dh 4Eh 0Dh 0Ah),
- Scale tarring (calling  $\rightarrow T \leftarrow$  key press) :  
Computer→Scale: S T CR LF (53h 54h 0Dh 0Ah),  
Scale→Computer: without response,
- Scale zeroing (calling  $\rightarrow 0 \leftarrow$  key press):  
Computer→ Scale: **S Z** CR LF (53h 5Ah 0Dh 0Ah),  
Scale →Computer: without response,
- Scale turning on / off (calling I/⏻ key press):  
Computer→ Scale: **S S** CR LF (53h 53h 0Dh 0Ah),  
Scale →Computer: without response,

- Entering to special function menu (calling *MENU* key press):  
Computer→ Scale: **S F** CR LF (53h 46h 0Dh 0Ah),  
Scale →Computer: without response,
- Setting threshold 1 value (option):  
Computer→ Scale: **S L D1...DN** CR LF (53h 4Ch D1...DN 0Dh 0Ah)  
D1...DN – threshold value, maximum 8 characters („-” – negative value, digits, dot – decimal separator), number of digits after dot should be the same as on scale display,  
Scale →Computer: without response,  
Example:
  - in order to set low threshold 1000g in scale B1.5 (d=0.5g) the following order should be sent:  
S L 1 0 0 0 . 0 CR LF (53h 4Ch 31h 30h 30h 30h 2Eh 30h 0Dh 0Ah),
  - in order to set low threshold 100kg in scale B150 (d=50g) the following order should be sent:  
S L 1 0 0 . 0 0 CR LF (53h 4Ch 31h 30h 30h 2Eh 30h 30h 0Dh 0Ah),)
- Setting threshold 2 value (option):  
Computer→ Scale: **S H D1...DN** CR LF (53h 48h D1...DN 0Dh 0Ah),  
D1...DN – threshold value, maximum 8 characters  
Scale →Computer: without response.
- Setting threshold 3 value (option):  
Komputer→Waga: **S M D1...DN** CR LF (53h 4Dh D1...DN 0Dh 0Ah),  
gdzie: D1...DN – threshold value, maximum 8 characters  
Waga→Komputer: without response.

**Connecting cable WK-1 (scale – computer / 9-pin interface):**

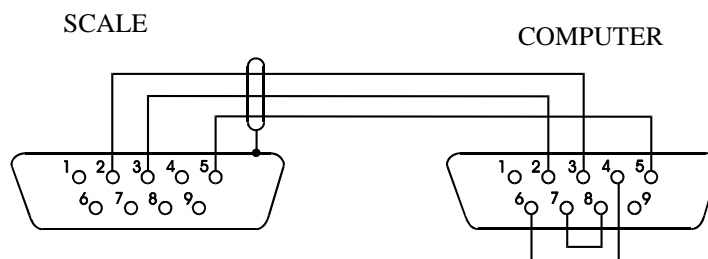

**Connection cable WD-1 (connects scale with AXIS printer):**

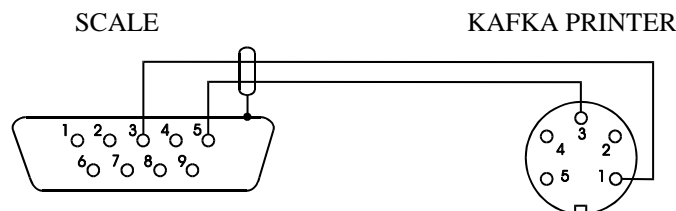

**Setting of internal switches of AXIS printer:**

SW-1	SW-2	SW-3	SW-4	SW-5	SW-6	SW-7	SW-8
on	off	on	off	off	on	off	off

## 9.6 Detailed EPL protocol description

Transmission parameters: 8 bits, 1 stop bit, no parity, baud rate 9600bps,

- After using  key in scale:
- Scale→Label printer : set of instruction in EPL-2 language that initialize label printing:

US	- Steering instruction
FR"0001"	- Label number define instruction
?	- Instruction that starts list of variable signs
mm:gg	- 5 signs: minutes:hour
rrrr.mm.dd	- 10 signs: year.month.day
masa	- 10 signs: scale indication+ mass unit
P1	- Steering instruction

### **Attention:**

1. Except variable signs constant signs can also be inscribed e.g. factory name, product name and so on.
2. In standard only one label pattern is possible to printout (number 0001). Using bigger amount of patterns (other label numbers) is possible thanks to *LABEL* special function.
3. To achieve label printout, label printer must have inscribed label pattern (label pattern is created on computer and using computer it is saved to label printer memory). Label pattern is designed by ZEBRA DESIGNER program which is supplied together with label printer.

Scales parameters and transmission protocol must correspond to label printer type.

## 10. Accumulator change in aluminium meters

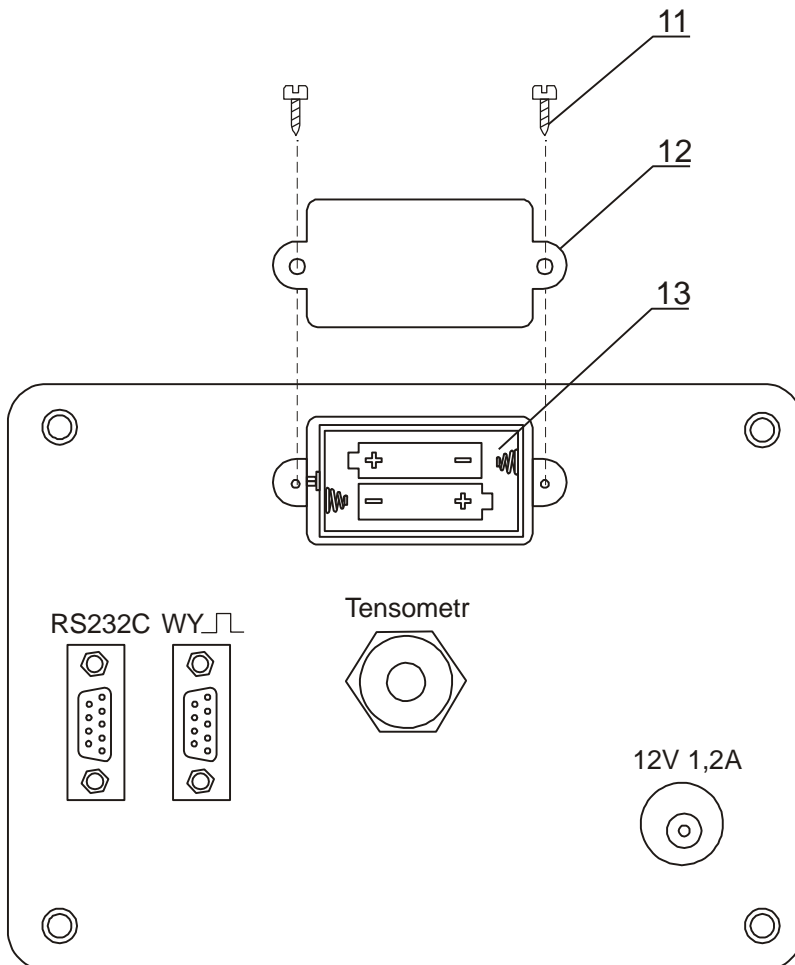

1. Remove screws 11 holding plate 12, remove the plate.

Take out container with accumulators 13 and place 4 AA format accumulators. The way of packing accumulators into the container is shown on the figure on the left and is also shown on the container.

## 11. General rules of using scale

1. Before each measurement make sure that zero indicator is displayed. If zero indicator does not display or "----" communicate appears, press →0← key and wait until zero indication and zero indicator appears.
2. The scale is equipped with a tare equal to its range. To tare the scale press →T← key (left or right). Storing a tare value does not extend measuring range, but only subtracts it from a load placed on a pan. To make weight control easier and to avoid range overdrawing, the scale (with LCD) is equipped with a load indicator (graduated in percentages).
3. Weighing result should be read when the indicator "▲ ▲" lights, which signalises result stabilization.
4. When the scale is not used but it is necessary to be ready to work immediately, it can be switched off by pressing I/⏻ key. The scale reading system is then switched off to "standby" mode (signalled by the indicator "OFF" in version with the LCD display). To switch the scale on press I/⏻ key. The scale is immediately ready to operate maximum accuracy (after self tests).
5. Weighed sample should be placed in the centre of the pan.



***Place the scale on a platform to avoid dropping weighed objects on the pan.***



***Do not overload the scale more than 20% of maximum load (Max).***

6. Protect the scale against dust, aggressive dusts and liquids. To clean the scale wash it with water with soap and dry it afterwards.
7. A scale equipped with accumulators (option) automatically charges during normal work with feeder and controls accumulator state. Charging control is executed by *bAtterY* special function. The function enables to readout charging state and also to turn off charging in case of using normal batteries (instead of accumulators). Meter signalizes an accumulators discharge on LCD display and after around 1h the scale switches itself off to avoid discharging the accumulator below threshold voltage.



***Do not allow to fully discharge the accumulator as this could damage it!***

After discharge signalling appears an accumulator should be charged as quickly as possible by connecting external feeder. Charging is more effective when scale is turned off with I/⏻ key, then charging time is about 10 hours.

## **12. Balance checking and adjustment**

It is advised to check scale indication accuracy before and after series of measurement using any load with known weight.

To check the scale with legal verification use a calibration weight with valid calibration certificate. In case permissible error is exceeded it is advised to contact the nearest service to calibrate the scale.



Adjusting (calibration) scale should be made if the scale precision is not sufficient. A standard of mass should be used with Max value taken from scale technical data table. In case of legalized scales with inaccessible calibration (secure seal) contact with service is recommended.



### 13. Start-up

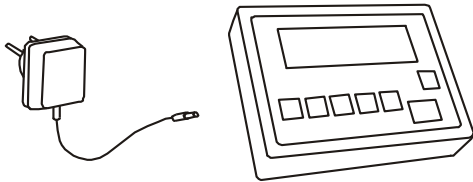

Leave the pan empty, plug a scale to the mains with a ground contact. The scale proceeds with following start-up actions:

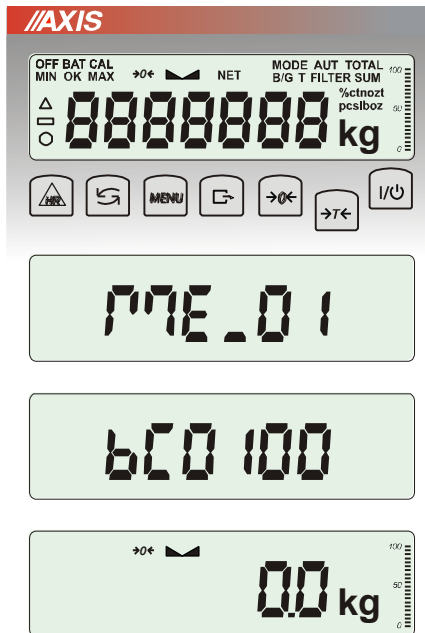

Display test.

Meter type displaying

Program version

The scale is now ready to work.

**Attention:**

Displaying program version means positive result of all tests.

### 14. Weighing with tare

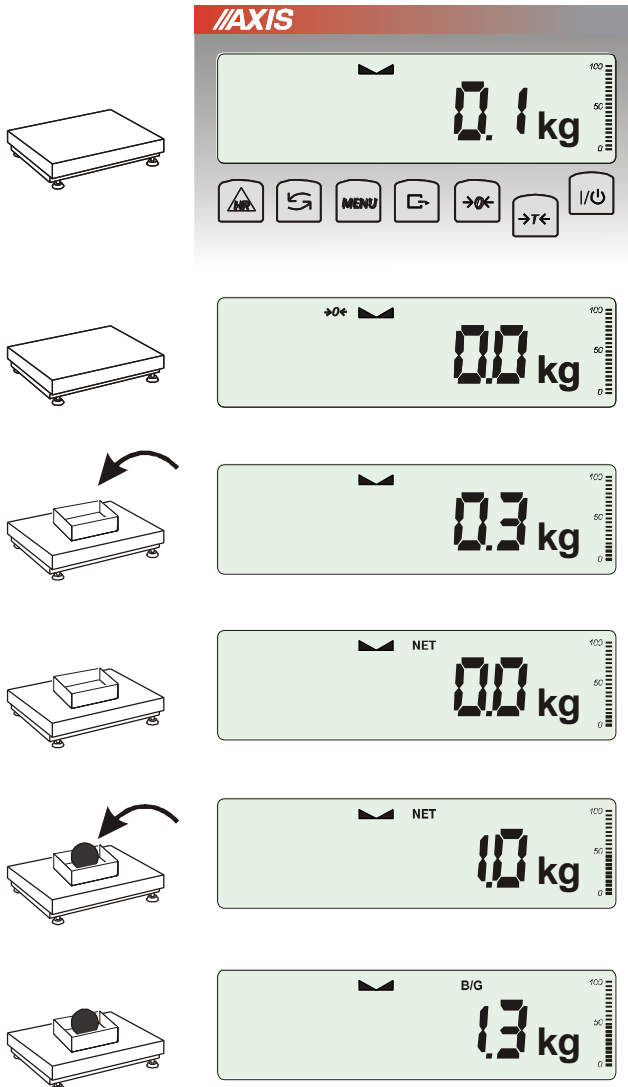

If the scale is not loaded and →0← indicator doesn't indicate, press →0← key.

Zero indication and →0← indicator mean that the scale is ready to work.

After putting container (package) tare the scale using →T← key. NET indicator will show up.

Put on weighted object and readout net weight (NET indicator shows that scale indicates net weight).

In order to readout gross weight press ↻ key (B/G indicator shows that scale indicates gross weight). Press again ↻ key in order to come back to net indications.

## 15. Scale menu

All scales except for basic metrological functions: weighing and taring, have many special functions and configuration options.

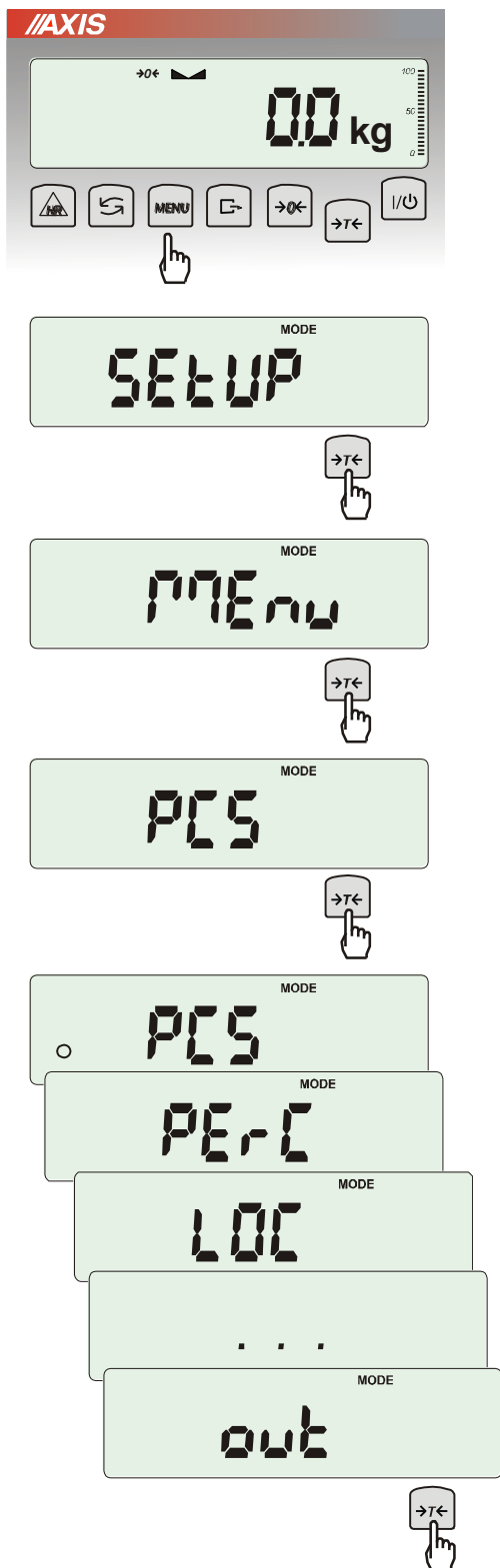

In order to ease using functions user can create his own (personalized) menu.

*Creating personalized menu:*

In „out of the box” scale after pressing *MENU* key only *SEtUP* option (it contains all configuration options) is available.

One of the configuration options is *Menu* that is used to create personalized menu.

To add a function to personalized menu press  $\rightarrow T \leftarrow$  key when the function is indicating.

Chosen function is indicated with „o” sign on the left side of display.

After adding all necessary functions press *out* in order to come back to weighing mode. User now after pressing *MENu* key has access to selected earlier functions and to *SEtUP* option. *dEFAULT* option is used to set factory settings.

## 16. Menu navigation rules

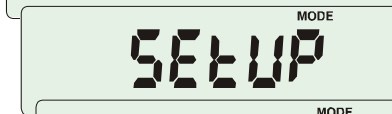
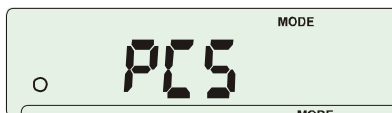
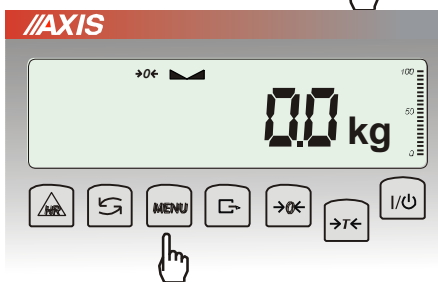
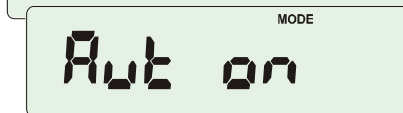
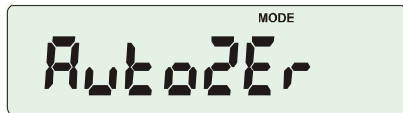
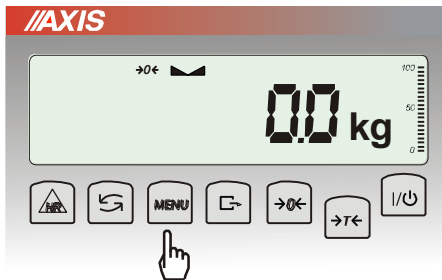

### Choosing menu options:

First position of scale menu shows up after pressing *Menu* key. The position is displayed for about 7 seconds and then the scale sequentially displays next menu positions.

Choosing menu position (option) is done by pressing →T← key when it is displayed on the screen.

After choosing position (option) usually several options show up:

- on – turning on selected option,
- OFF - turning off,
- out – out to menu.

### Accelerated working with menu:

Menu first position is displayed for about 7s. During this time user can view next positions by using ↶ key (or →0←).

Immediate out to previous menu level is done by using *Menu* key.

 key working method:

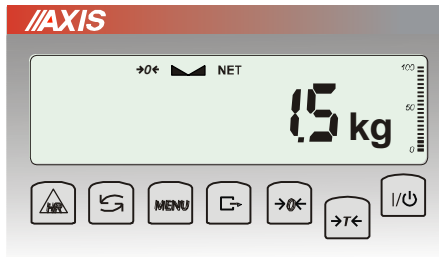
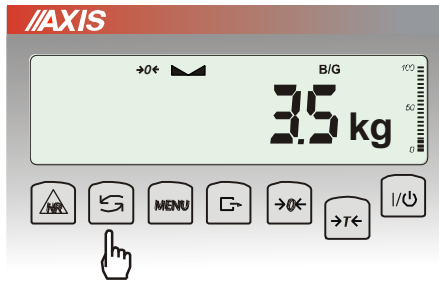
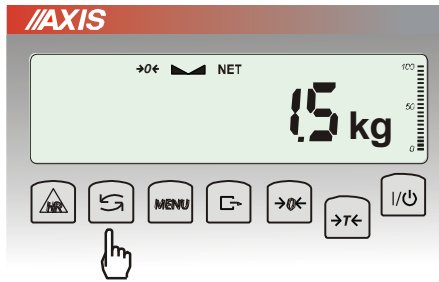

During standard weighing  key is used to switch between net and gross indication.

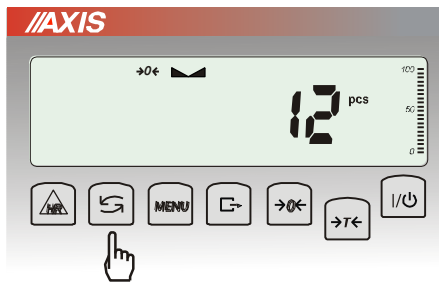

When special function e.g. PCS is turned on, using  key enables to go back to standard weighing mode.

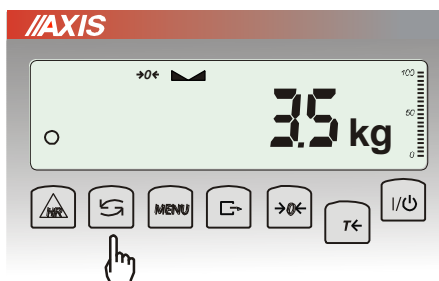

Sign „0” on the left side signalizes that special function is turned on and user can go back to function mode by pressing  key.

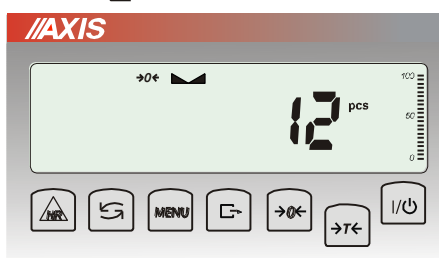

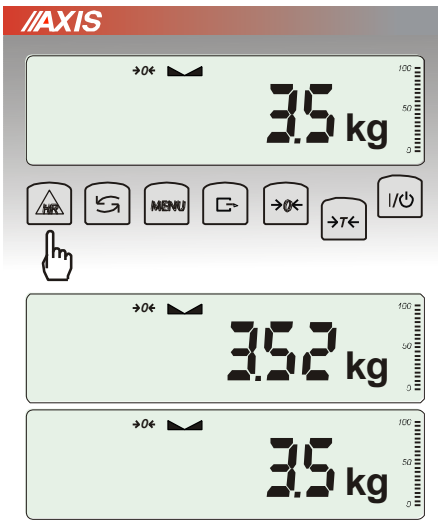

5s.

*HR key working method:*

During normal weighing temporary (5s) readout resolution increase is possible.

Return to normal indication is made automatically.

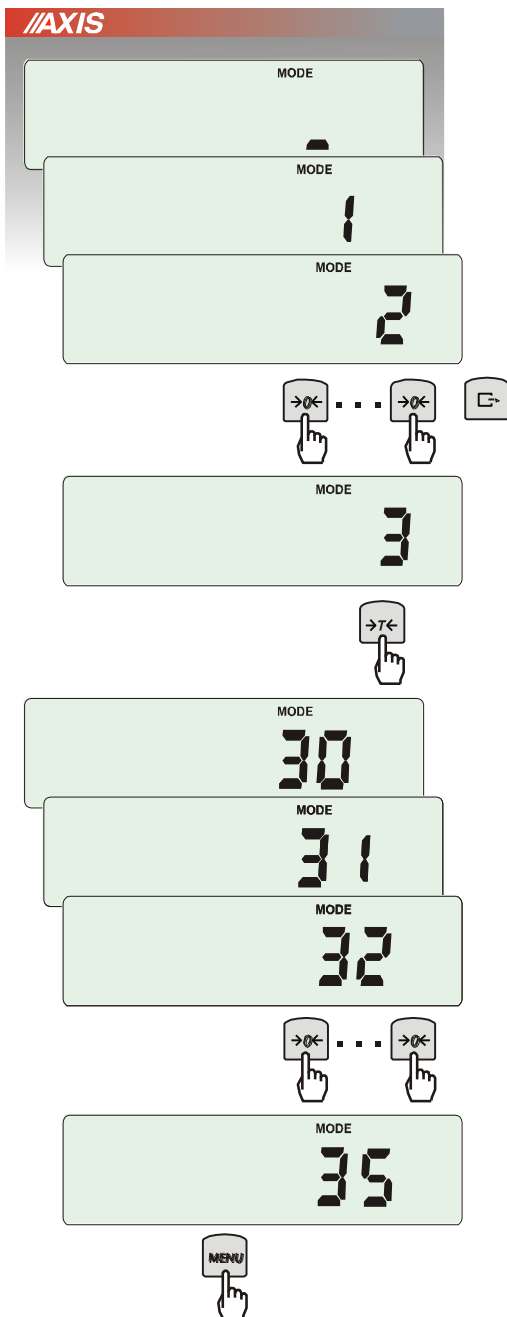

*Inscribing numerical values:*

Inscribing numerical values is needed in some special functions e.g. *tArE* function requires to inscribe tare values.

**Keys:**

→0← - increasing digit value,

→.← - decimal point,

→T← - next digit position,

*MENU* - end of inscribing.

Menu diagram:

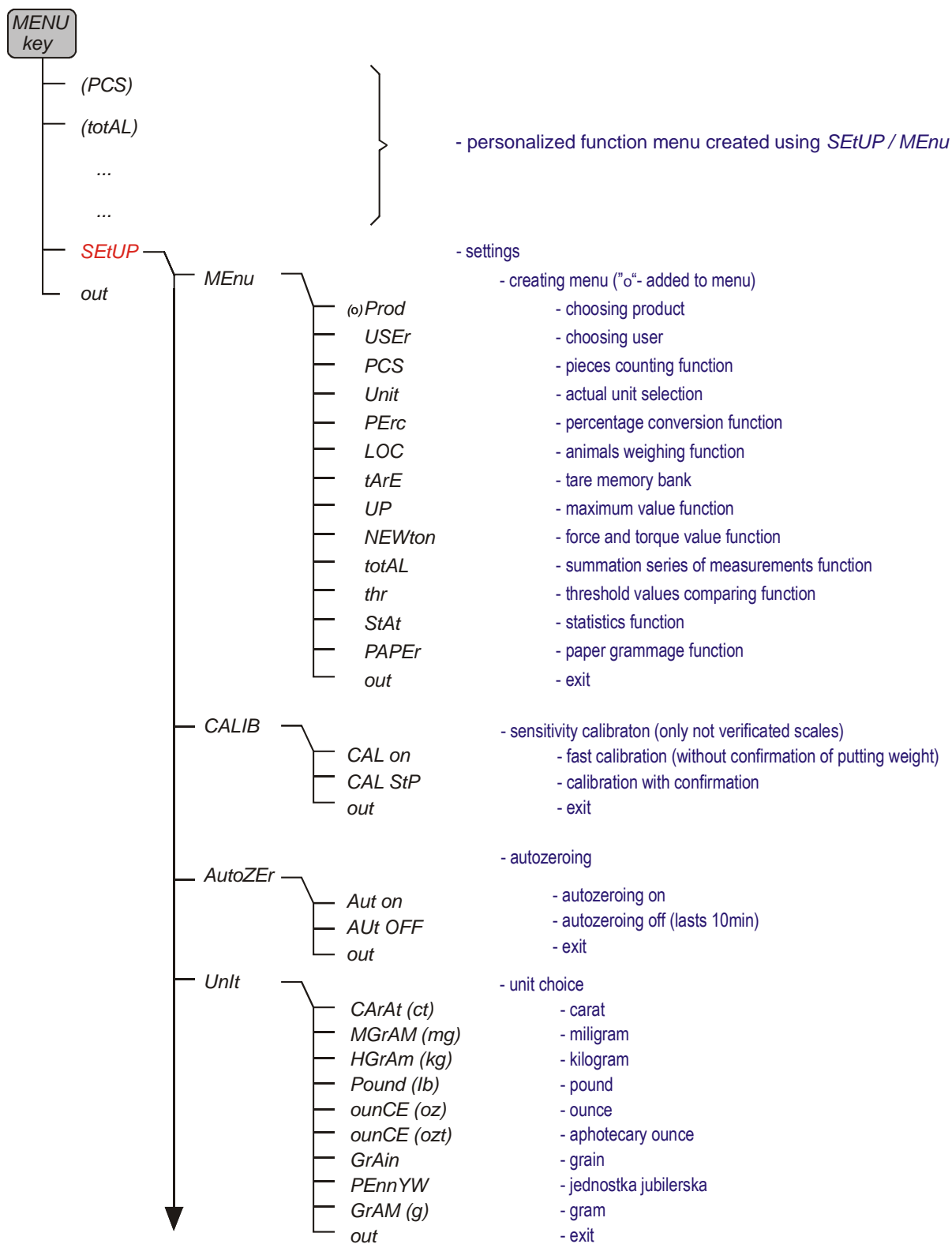

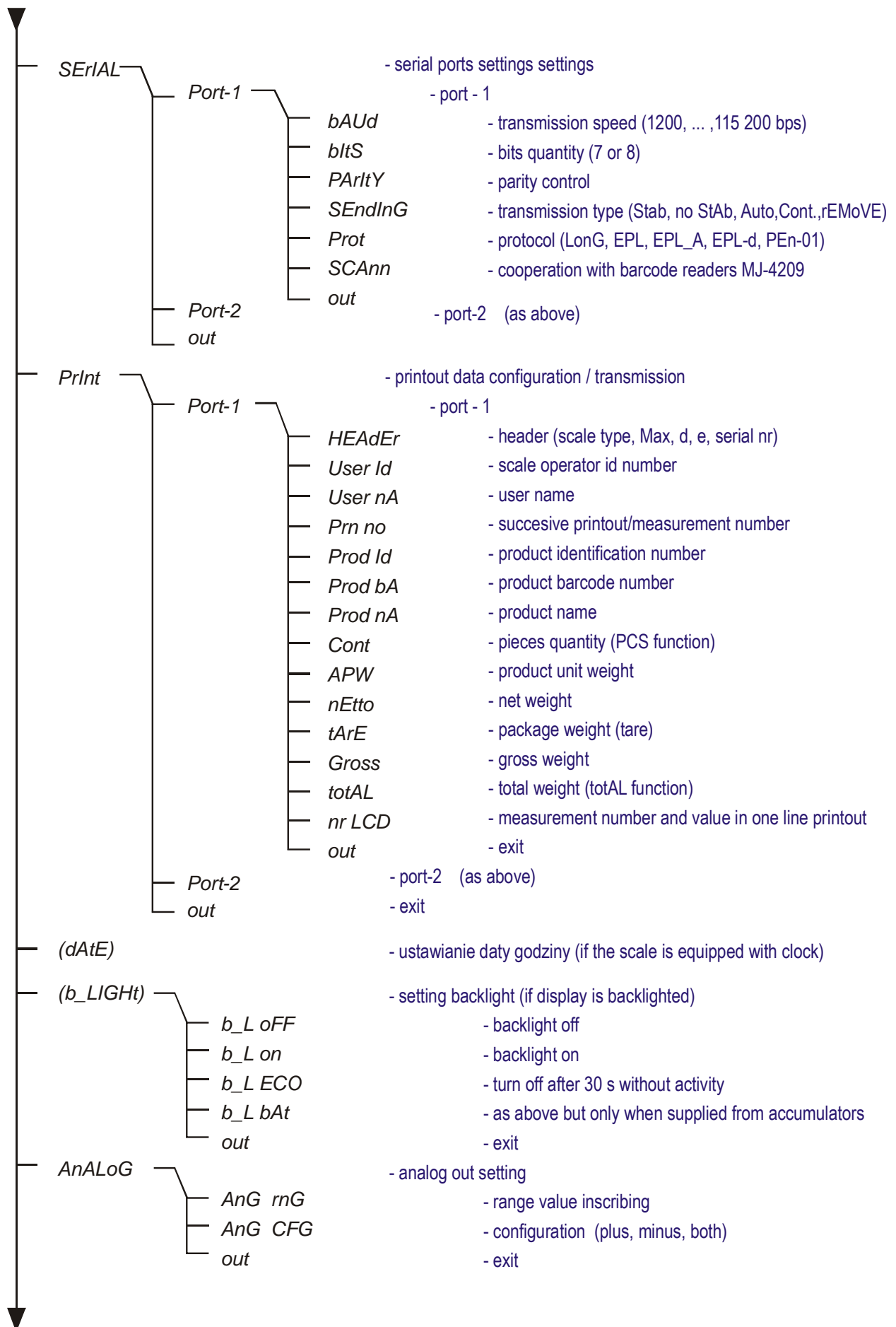



---



<i>(bAttEry)</i>	- turn on/off accumulator charging (if the scale is equipped with accumulator)
<i>(AUto OFF)</i>	- automatic turning off - saving accumulator power (as above)
<i>(ZEro)</i>	- scale start zero inscribing (factory zero)
<i>dEFAULT</i>	- restore default settings for all options
<i>SErVICE</i>	- options only for service
<i>out</i>	- exit

## 17. Scale setup (SEtUP)

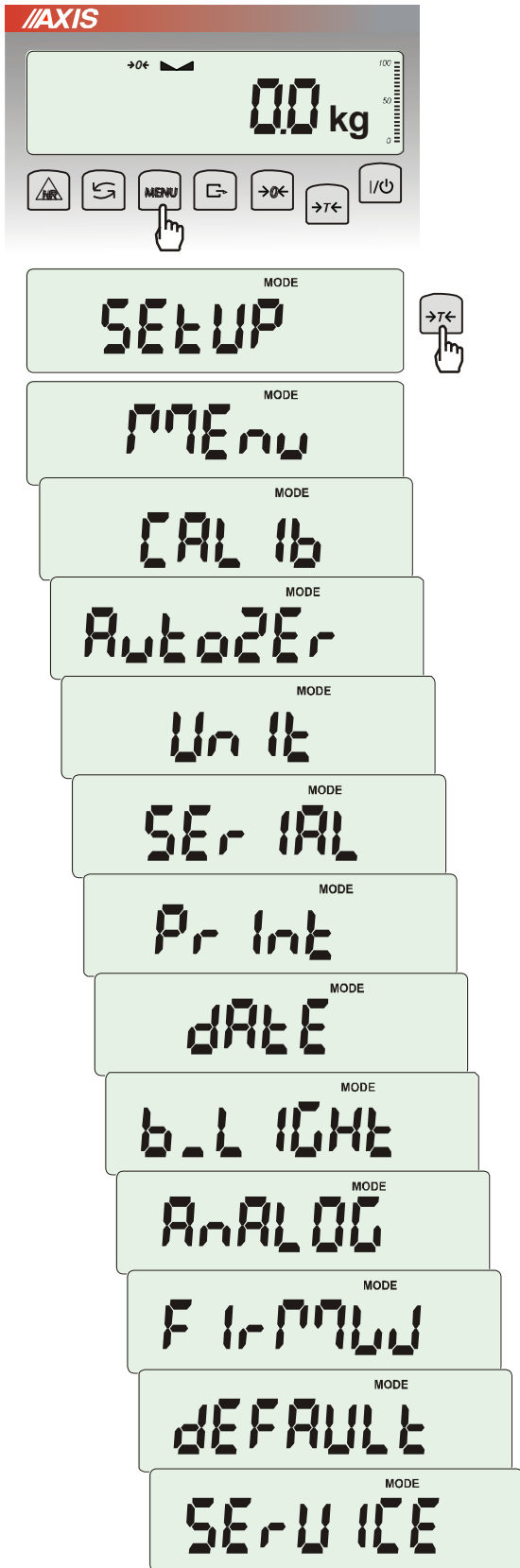

SEtUP contains all options used for setting scale work mode:

- ❑ *MEnu* – creating personalized user menu
- ❑ *CAL Ib* – scale sensitivity calibration
- ❑ *AutoZEr(ing)* – self-maintaining zero indication (unloaded scale)
- ❑ *Un It* – weight unit selection
- ❑ *SEr IAL* – setting serial ports
- ❑ *Pr Int* – transmission (printout) data selection
- ❑ *FILtEr* – anti-disturbance filter
- ❑ *b\_LIGHt* – backlight setting
- ❑ *Ad420* – analogue out configuration
- ❑ *FIrMw(are)* – updating software (only for service)
- ❑ *dEFAULT* – reset to factory settings (sample of using in chapter 15)
- ❑ *SErV ICE* – service menu (only for service)

### 17.1 Scale calibration (CAL**lb**)

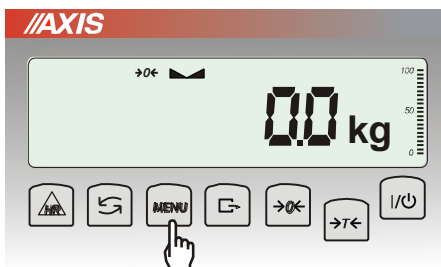

Press **MENU** key.

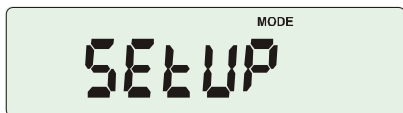

Press **→T←** key when **CAL**lb**** function appears.



The following options will be displayed:  
 -**CAL on** – calibration with external recommended standard of mass (see technical data).  
 -**CAL StP** – calibration with external weight, confirmation of successive steps - **MENU** key,  
**out** – leave without changes



Press **→T←** key when **CAL StP** option appears (calibration in two steps).

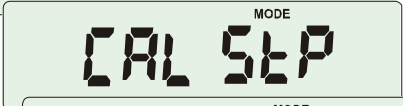

Press **→T←** key when weight value used for calibration is indicating or use **othEr** option and inscribe proper value ( keys **→0←**, **←**, **→T←** )

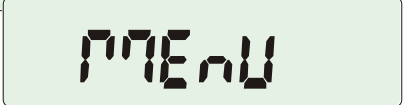
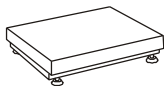

Press **MENU** and wait for writing zero to the scale.

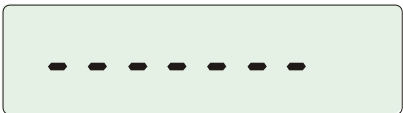

When **LOAD** message appears put standard of mass on the pan. Press **MENU** key (**CAL on** doesn't need pressing **MENU** key).

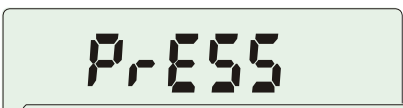

Wait until internal calibration is finished and zero indication is displayed.

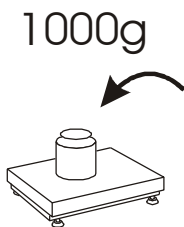

## 17.2 Autozeroing function (AutoZEr)

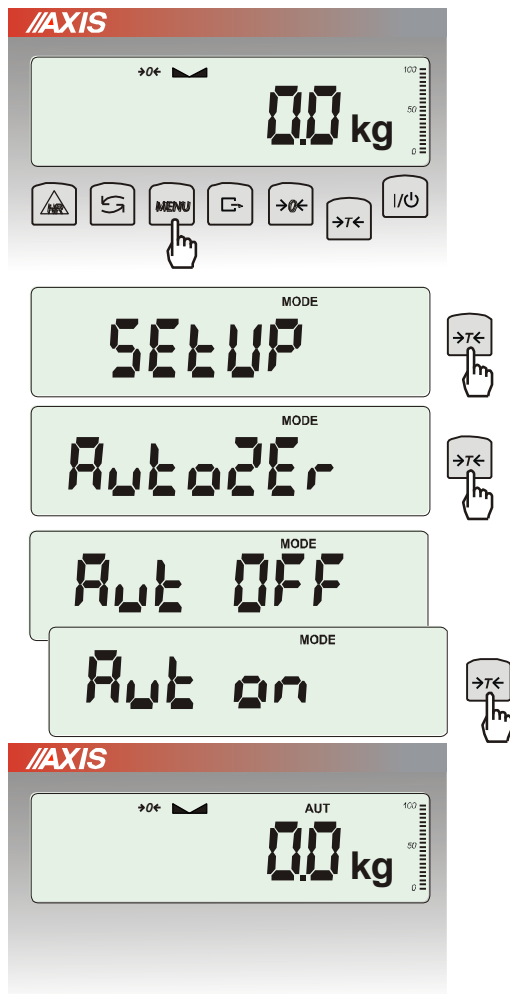

When the function is activated, the scale automatically ensures stable zero indication if the pan is empty or if zero indication was acquired by pressing **→T←** key.

To turn on the function use **MENU** key and using **→T←** key choose *AutoZEr* and then *Aut on*

To leave the function press **MENU** key, then with **→T←** key chose *AutoZEr* and *Aut OFF*.

Note:

1. *Aut* sign occurs only in scales with LCD display.
2. In scales with **→0←** key active function changes name into *AutoZE* (autozeroing) and works only when the scales is unbiased.

### 17.3 Weight unit selection (Unlt)

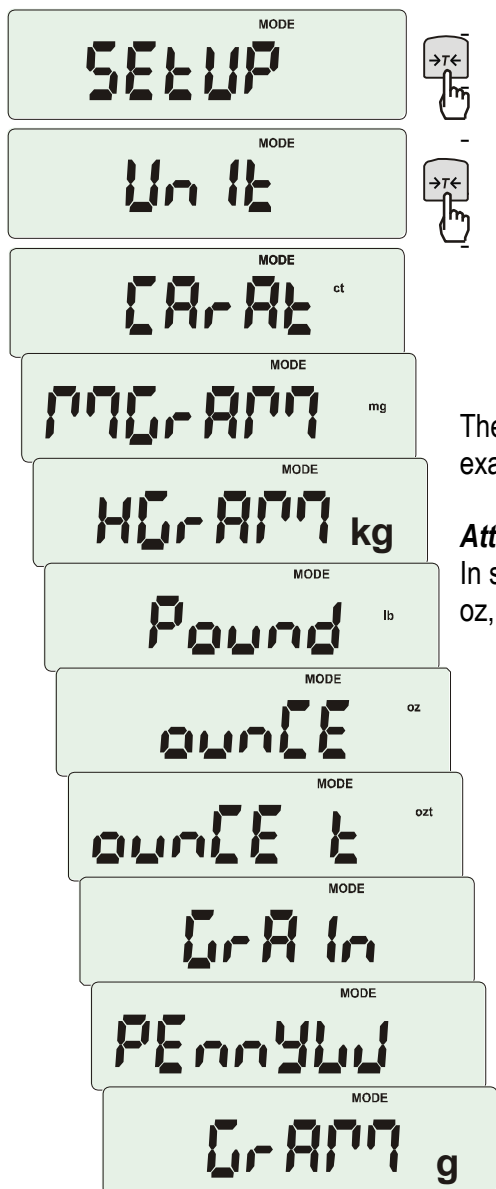
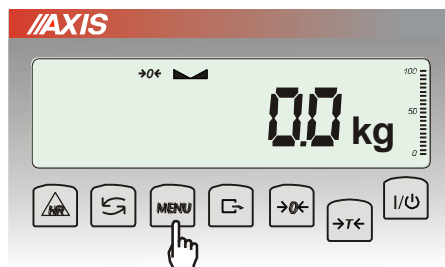

The function allows selecting weighing unit:

- CarAt (1 ct= 0,2 g) - carat,
- MGrAM (1mg=0,001g) milligram,
- KGrAM (1kg=1000g) kilogram,
- Pound (1 lb=453,592374g) English pound,
- OunCE (1oz=28,349523g) - ounce,
- OunCEt(1ozt=31,1034763g) pharmaceutical ounce,
- GrAln (1gr=0,06479891g) - grain
- PennYW (1dwt=1,55517384g) jewellery mass unit,
- GrAM (1g) - gram.

The way of choosing carats as weighing unit is shown on the example.



**Attention:**

In scale with LED display designations of mass units: lb, kg, oz, ozt, ct are not displayed. Units are pointed by diode light.

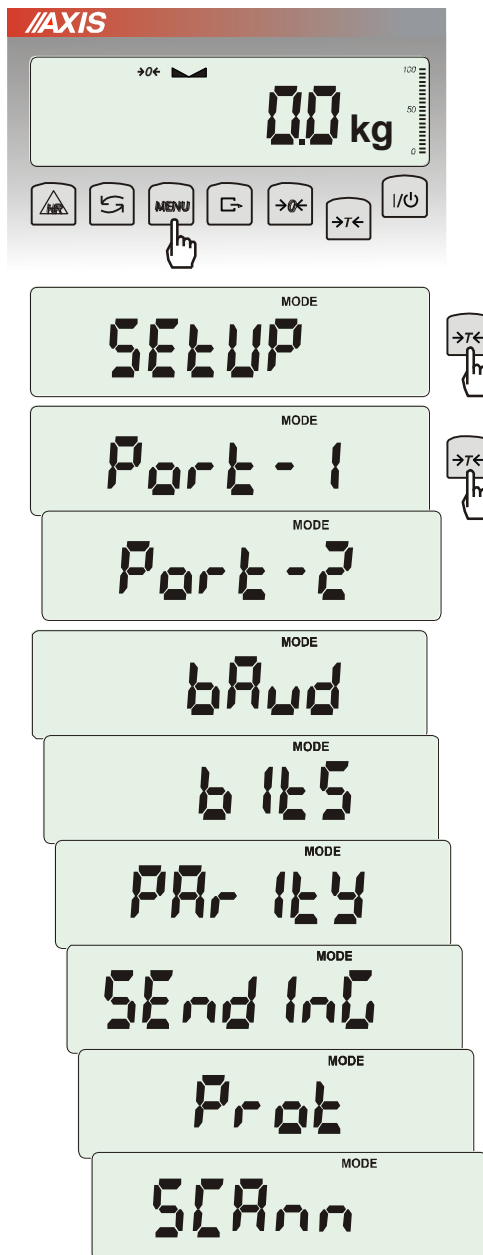
## 17.4 Serial port parameters setting (SErIAL)



The function allows setting independently communication parameters of both of serial ports *Port-1* and *Port-2* (executed in RS232C, RS485, USB or LAN standard):

- transfer protocol (*Prot*):
    - LonG* – cooperation with printer or computer,
    - EPL* – cooperation with label printer in normal mode (activates *LABEL* function),
    - EPL\_A* – cooperation with label printer in automatic mode (activates *LABEL* function),
    - EPL\_d* – cooperation with special label printers,
    - Pen-01* – cooperation with PEN-01,
  - baud rate (*bAud*): (4800, 9600, ....115 200bps),
  - number of bits in single char. (*bitS*): 7, 8,
  - parity control (*PARtY*):
    - nonE* – no control
    - Odd* – nonparity
    - Even* – parity control,
  - scale number in network (*nr*):
    - (if the scale doesn't work in network the number must be 0),
  - transmission through serial interface (*SEndInG*):
    - StAb* – transmission after  key is used and result is stable,
    - noStAb* – transmission after  key is pressed without need of stabilisation,
    - Auto* - automatic transmission after load is put on and result is stable (*Auto*),
    - Cont* - continuous transmission, about 10 results per second (*Cont.*),
    - Remove* – transmission after removing load.
- Default parameter values:  
*Long*, 9600 bps, 8 bits, *none*, *StAb*,
- *SCAnn* – cooperation with MJ-4209 barcode readers: *ON*, *OFF*.

In order to set needed parameters choose *SErIAL* function, select appropriate parameter and press  $\rightarrow T \leftarrow$  key when required option or parameter value is displayed.

In scales with an additional serial port appear *Port-1* and *Port-2*, for the independent setting of both ports.

## 17.5 Printout configuration (PrInt)

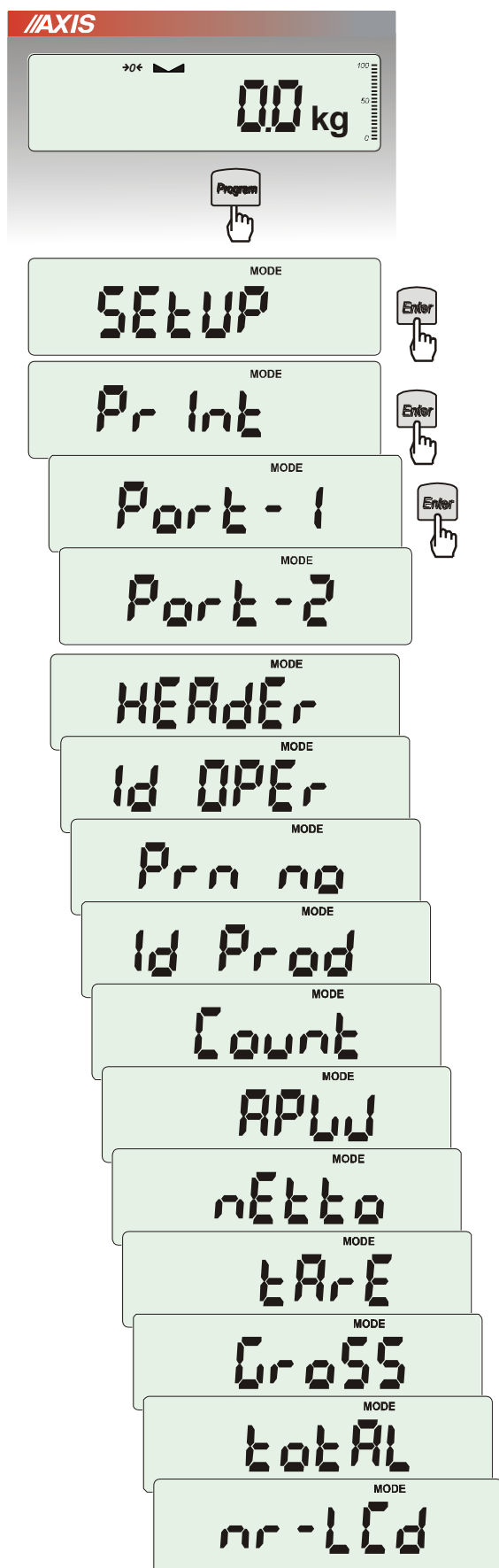

Function is used for printing additional information stored in scale memory, weighed product identification data and scale operator id. That information is inscribed using scale keys or scanner. After entering selected port (scale can have two ports) user may activate printout positions:

- *HEAdEr* – header: name, model and scale number,
- *USEr Id* – scale user identification number,
- *USEr nA* – user name,
- *Prn no* – successive printout number (choose this option to zero counter),
- *Prod Id* – product number,
- *Prod bA* – product barcode (inscribed or scanned),
- *Prod nA* – product name,
- *Count* – counting result (PCS function),
- *APW* – unitary mass (PCS function),
- *netto* – net mass
- *tArE* – current tare value,
- *GrOss* – gross mass,
- *totAL* – total mass (*totAL* function)

In printout configuration user can set if measurement (printout) number is saved after turning off the scale or not. Enter option *Print* and choose *Prn no*. Following options will appear:

- *rESEt* – resetting (zeroing) measurement number counter,
- *SAVE* – activate saving measurement number after the scale is turned off.

### Attention:

If *Prod Id* or *USEr Id* is chosen, it is possible to inscribe quickly their new values (with omission of main menu).

In order to do that hold (about 3 seconds) *MENU* key and release it when *Prod Id* or *USEr Id* indicates. Inscribe new value using keys:

- 0← - increasing digit,
- - decimal point,
- T← - next digit,
- MENU* - end.

While inscribing *Prod id* user can use barcode reader connected to RS232C interface.

If the scale is equipped with two serial joints *Print* function is set independently for both interfaces.

**Sample printout during normal weighing (all printout positions deactivated):**

```
20.07 kg
20.04 kg
20.04 kg
```

**Sample printout during normal weighing with clock option (all printout positions deactivated):**

```
20.07 kg 2012-11-08 10:01
20.04 kg 2012-11-08 10:01
20.04 kg 2012-11-08 10:01
```

**Sample printout during normal weighing ( some printout positions activated):**

```
BA30
MAX: 30kg e=d=0.01kg
S/N :

ID OPER.      : 000001
DATE          : 2012-11-08
TIME          : 12:26
NO            :          3
ID PROD.      : 01
COUNT        : 0 PCS
APW           : 0.000 g
NET           : 3.08 kg
TARE          : 0.00 kg
GROSS         : 3.08 kg
TOTAL         : 0.00 kg
```



## 17.6 Setting backlight function (b\_LIGHT)

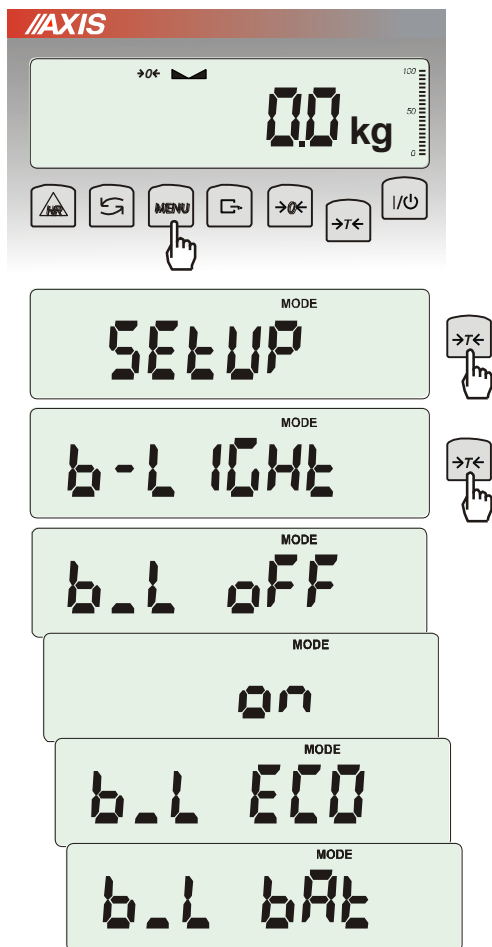

The function is used for choosing the work mode of scale display backlight:

- *b\_L OFF* – switch backlight off,
- *b\_L on* – switch backlight permanently on,
- *b\_L ECO* – switch off after 30 seconds of inactivity (no load changes and no key operation),
- *b\_L bAt* – like above, but when powering from accumulators only,
- *out* – out without changes.

Switching backlight off causes decrease of energy consumption by the scale, what is important during powering from accumulators.

## 17.7 Analog out configuration (AnALoG)



This option enables to set-up analog out (4-20mA or 0-10V) working method used e.g. in PLC regulators:

- *AnG r nG* – inscribing Max value
- *AnG CFG* – working mode configuration (*PLUS* – workmode for only positive values, *MinuS* – only for negative values, *both* – for both)

## 17.8 Entering reference zero value (ZErO)

**Note:** This function is enabled in non-legalized scales only.

ZErO function allows entering new value of reference zero (value referred to empty pan) without need of contacting with authorised service centre.

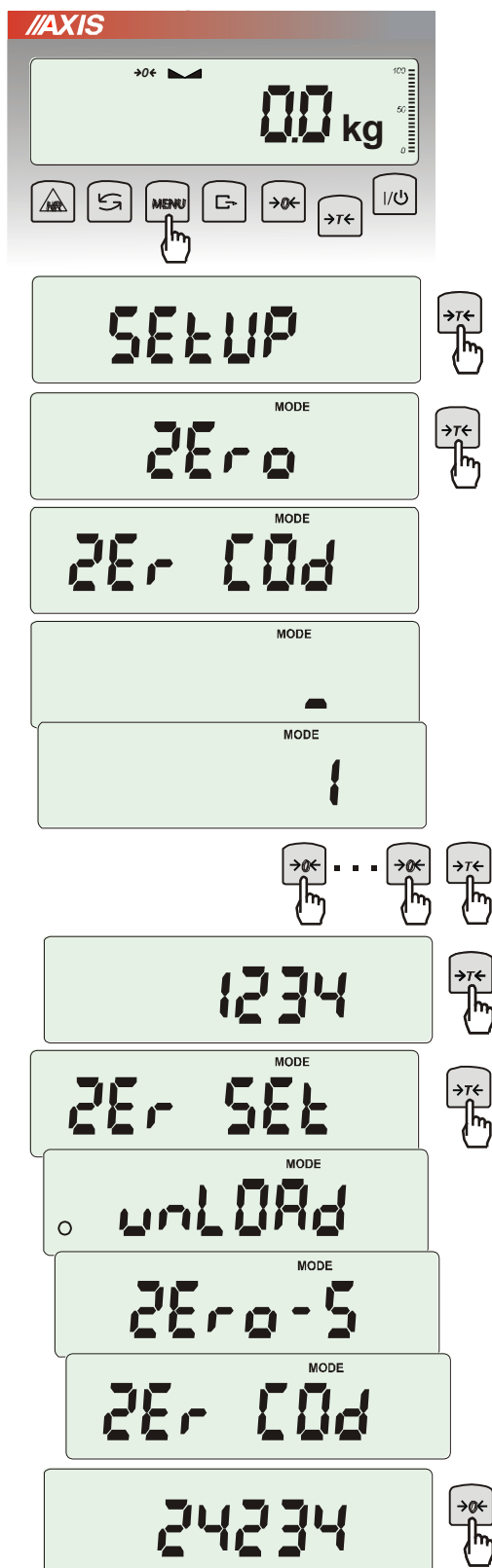

Press *MENU* key.

When *ZErO* is displayed press →T← key.

On the display a sign *ZEr Cod* will show up momentary and the a dash on last digit position.

To enter code ( in new scale: 1234) use keys:

→0← - increasing digit,

→T← - next digit,

*MENU* – end of inscribing.

The following options appear successively on display:

*ZEr Cod* – enter new secure code value,

*ZEr SEt* – enter new zero value

Using →T← key, choose *ZEr SEt*. Direct result from A/C converter will appear on scale display.

When the pan is empty press →0← key.

Wait for finishing zeroing process.

In order to change access code use *ZEr Cod* option (as mentioned earlier).

## 18. Special functions description

All scales besides basic metrological functions: weighing and taring, have a set of special functions. Depending on meter type functions set differs. Below a list of functions available in standard ME-01 type meters:

- ❑ Products data base (*Prod*),
- ❑ Users data base (*USER*),
- ❑ pieces counting function (*PCS*),
- ❑ change of mass unit (*UnIt*),
- ❑ percentage weighing function (*PErC*),
- ❑ selecting label number function (*LABEL*),
- ❑ weighing large animals function (*LOC*),
- ❑ entering tare function (*tArE*),
- ❑ maximum value indication function (*UP*)
- ❑ force measuring function (*nEWton*)
- ❑ statistical calculations (*StAt*)
- ❑ paperweight calculation function (*PAPER*)

and functions that require additional equipment to be completely functional:

- option with accumulator supply:
  - Setting accumulators charging (*bAttErY*)
  - Automatic switching off scale function (*AutoOFF*)
- options with the clock:
  - setting current date and time function (*dAtE*)
  - total weight function (*totAL*)
- options with the transoptors connectors (*WY<sup>TF</sup>*):
  - checkweighing function (*thr*)
- option with radio connection:
  - function of choosing communication channel (*rF Chn*)

LabEL function is available in scales with EPL or EPL-A transmission protocol activates (go to *SetuP/SERIAL*).

In scales with LED display special functions don't have additional marks on display and names of some functions are shortened.

## 18.1 Products and users database (*Prod i USEr*)

Scale is equipped with products and users database with capacity up to 400 products and 100 users. Database consists of:

- *M nr* – memory number where data is saved,
- *Prod Id* - product identification number,
- *Prod bA* – product barcode,
- *Prod nA* – product name,
- *USEr Id* – user identification number,
- *USEr nA* – user name,
- *APW* - unitary weight (used when pieces counting),
- *PtArE* - inscribing permanent tare to the product,
- *thr Lo* - threshold value (low),
- *thr Hi* - threshold value (upper),
- *LAbEL* – corresponding label number.

Database can be built in Excel datasheet form, where each product has one row and each column have product data. This way created database, saved in \*.csv extension with semicolons can be send to scale using *Scale Database* software and scale's serial interface. *Scale Database* is available on our webpage [www.axis.pl/en](http://www.axis.pl/en).

Database and possibility to cooperate with external devices: printer, label printer, barcode reader and computer enables to built product identification and product archiving systems.

Product barcode readout (during scale working) initiates searching through database and in case of finding proper record, recalls product data (*Found* communicate). Barcode reader enables also to insert numerical data conveniently (standard ME-01 meter doesn't have numerical keys). Using alphanumeric code (for example 128 code) it can be also used to insert names of products and users.

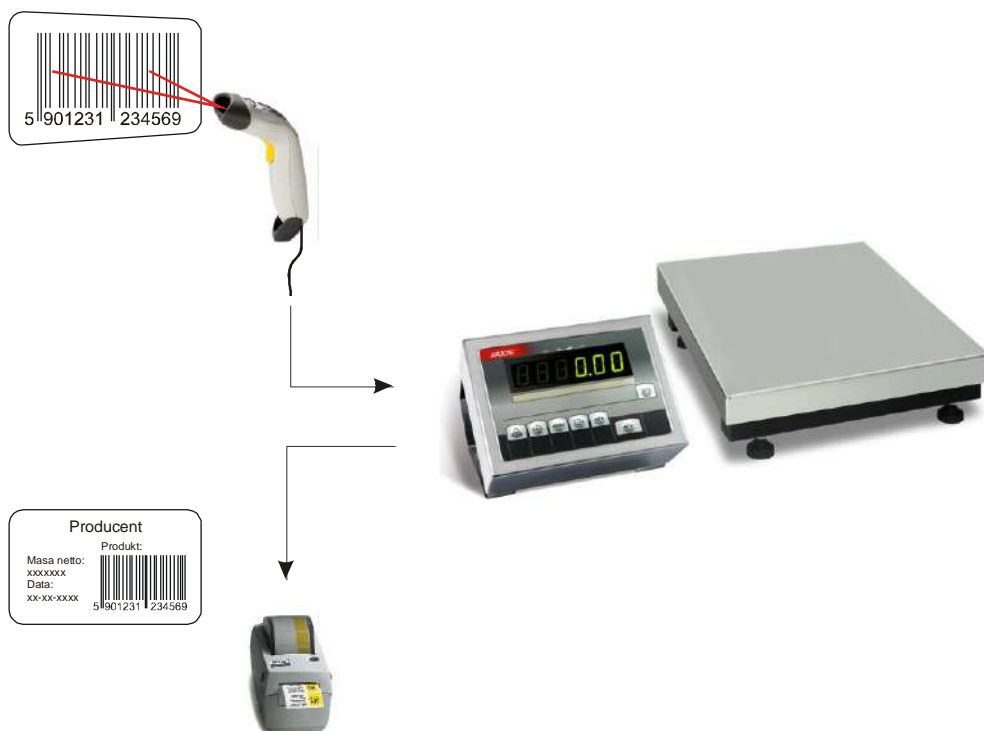

## Inscribing data to base

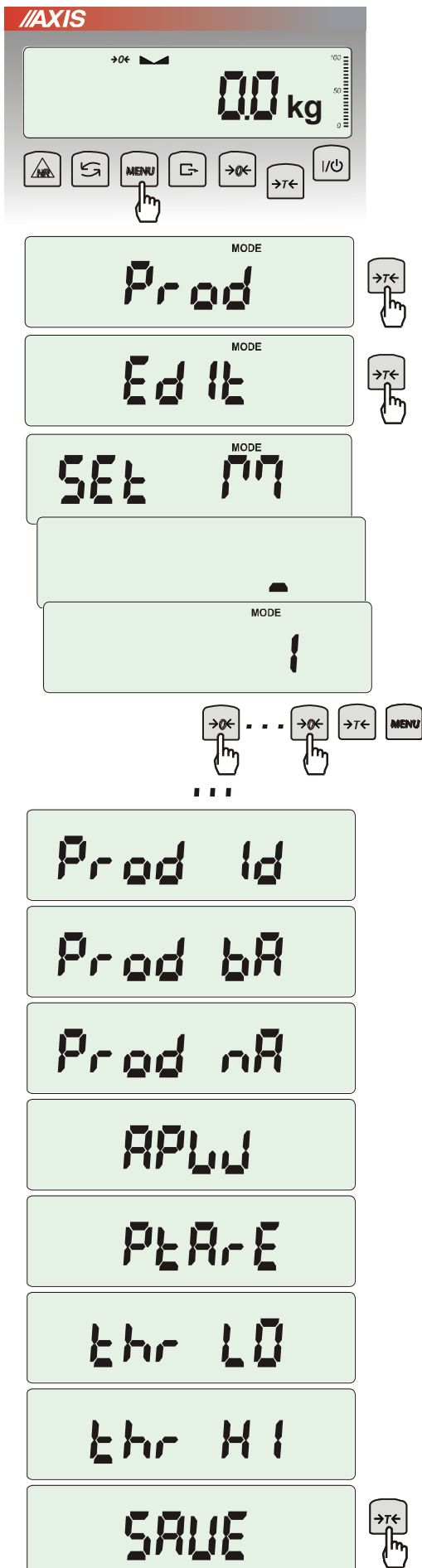

*Prod* and *USER* options enables adding and deleting product and user data.

For products database available options are:

- *Prod Id* – searching for product in database by inscribing (or scanning) id number or barcode,
- *ProdCLr* (shows up if product was selected earlier) – turns off actual product selection,
- *EdIt* – product edition from database,
- *Add* – add product to database,
- *dEL OnE* – deleting single element from database,
- *dEL ALL* – deleting all elements from database,
- *dAtAb* – changing working mode with database (default mode *Stb*):
  - *Stb* – searching products in database and working with products outside the base; if product is found then *Found* communicate appears and all product data is recalled; if there is no product in database then no communicate appears, the scale stores id/barcode number temporarily in memory and enables to send it to the port (to printer/computer) together with actual weighing result.
  - *LIMit* – searching through products from database; if product is found then *Found* communicate appears and all product data is recalled; if there is no product in database then *not Found* communicate appears.
- *Prn\_P* – sending all products database to port.

To inscribe data use *EdIt* option and keys:

→0← - increasing digit,

→T← - next digit,

MENU – end of inscribing.

Barcode reader (connected to RS232C interface) can also be used to inscribe data and this way it is faster and more effective.

Each database product has following data:

- *M Id* – memory cel number in products database,
- *Prod Id* – product identification number,
- *Prod bA* – product barcode,
- *Prod nA* – product name (inscribed from PC or barcode reader),
- *APW* – product unitary weight (optional),
- *PtArE* – product package weight (optional),
- *thr LO* – lower threshold (MIN value),
- *thr HI* – upper threshold (MAX value).

Saving inscribed product data is done by using *SAVE* option.

Users database is edited by similar function named *USER* and consists of several options:

- *USER Id* – user identification number,
- *USERCLr* (shows up if user was selected earlier) – turns off actual user selection,
- *USER nA* – user name (inscribed from PC or scanner),
- *Prn\_U* – sending users database to port.

Saving data is also done by *SAVE* option.

**Recalling from database**

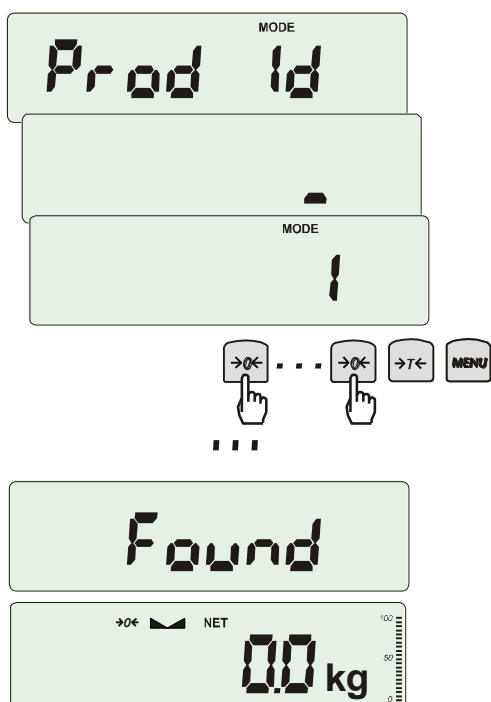
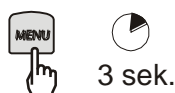
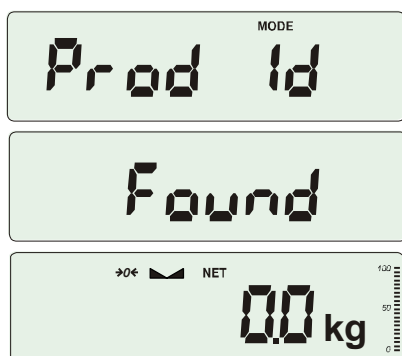

The fastest way to recall product from database is to readout his barcode number (*Prod bA*) by using barcode reader (option). It can be done in any moment.

After readout of proper barcode scale indicates one of communicates:

- *SCAN* – barcode from outside the base accepted (*Std* mode),
- *not Found* – barcode from outside the base not accepted and no product is selected (*LIMIT* mode),
- *Found* – product barcode found in database and data recalled.

**Attention:** If the scale doesn't indicate any communicate, check barcode reader connections, port configuration and transmission protocol (*SERIAL* function).

Other fast way is to press and hold *MENU* key (about 3s). *Prod Id* communicate will appear. Release the key and inscribe identification number. If the number is already saved in base *Found* communicate appears and all the product data is recalled.

To edit data choose *EdIt* option and use following keys:

- 0← - increasing digit,
- T← - next dixit,
- MENU – end of inscribing.

Product recalling is also possible by using *Prod* and *Prod Id* options (previous site).

If You hold *MENU* key for a longer time (about 6s) *ProdCLr* communicate will appear and actual product selection will be turned off.

**Weighing results and data transmission from scale to computer or to printer**

To fully use database capabilities other options must also be used: *Serial*, *Label* (for label printer) and *Print*.

*Serial* option enables to select proper transmission protocol for each port. Thereby label printer can work independently. Recalling product is equivalent with choosing corresponding label number. If database is not used, proper label can be choosed using *Label* option.

To each weighing results transmission a set of product and user identification data is added. The set is activated in *Print* option.

Available data from products and users base (*Print / SEtuP* option):

- *USEr Id* – user identification number,
- *USEr nA* – user name (inscribed from PC or scanner).
- *Prod Id* – product identification number,
- *Prod bA* – product barcode (inscribed or scan),
- *Prod nA* – product name (inscribed from PC or scan),
- *Label* – label number for proper product,
- *APW* – unitary mass (PCS function),
- *tArE* – tare,
- *totAL* – total mass (*totAL* function).



## 18.2 Pieces counting function (PCS)

The diagram illustrates the PCS function steps. It shows a scale with an empty pan, then a pan with 5 pieces, and finally a pan with 15 pieces. The scale display shows the transition from 0.0 kg to 1.3 kg, then through various PCS mode screens (PCS, PCS OFF, PCS ON, PCS . . ., PCS 5, PCS 500, PCS SET, PCS APW, PCS r5), and finally to 5 pcs and 15 pcs.

This function enables to count identical pieces, e.g. turnbuckles or buttons.

A measurement is performed in two phases:

- first phase - single piece weight calculation on the basis of defined pieces amount (5, 10, 20, 50, 100, 200 or 500 pieces),
- second phase – pieces counting.

First phase options:

- PCS . . – recalling of a value inserted earlier (this quantity must be inscribed earlier),
- PCS SET – set any amount of pieces in a sample,
- PCS APW – set unitary mass directly,
- PCS rS – inserting number of details in a sample and receiving of their mass from other scale connected by RS-232C.

It is advised that single piece weight is not less than one reading unit and sample weight used in first phase is bigger than 100 reading units.

To leave function press MENU key and then using →T← key chose PCS and PCS OFF.

**Note:**

1. APW too LOW communicate signalises that a sample was not put on the pan or if single piece weight is less than one-tenth readout plot (counting is not possible).
2. APW LOW communicate signalizes that single piece weight is more than one-tenth but less than one readout plot. (counting possible but with bigger errors, result blinks).
3. In scales equipped with LED display pcs sign is replaced with “■”.

### 18.3 Percentage weighing function (PErC)

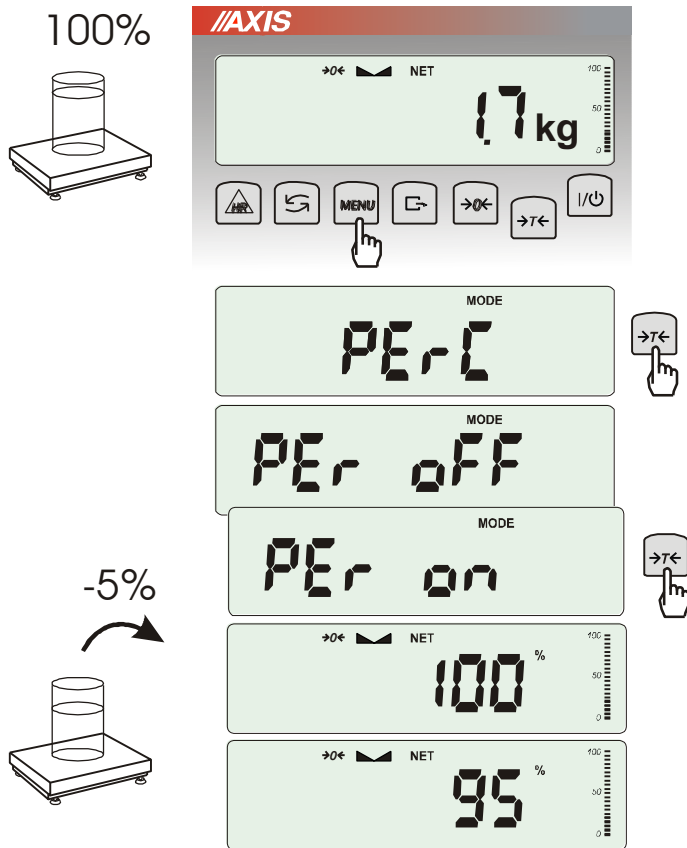

This function allows displaying weighing result in percents.

A measurement is performed in two phases:

- first phase – weighing a reference sample (100%),
- second phase – measuring specific sample as a percentage of the reference sample.

Weighing result is displayed in different format, depending on the weight value of reference sample.

The function has the following options:

- *PEr OFF* – disable the function,
- *PEr on* – set current scale indication as 100% and activate percentage weighing,
- *out* – exit without changing settings.

#### Note:

1. *PEr Err* message informs that reference 100% mass is less than  $0,5 \cdot \text{Min}$  or was not defined.
2. In scales with LCD display sign "■" is replaced with %.

### 18.4 Label choosing function (LAbEL)

This function is used in scale with *EPL* (*SErIAL* function) data protocol. This protocol enables label printout with actual scale indication and chosen data from *Prnt* special function (variable data), for example date and time. Other data, for example company address, product name, barcode can appear on label as a constant text. Label patterns with number (4 digit) used by user should be saved in scale memory according to printer manual. Label pattern choice is made by inscribing label number using *LAbEL* function.

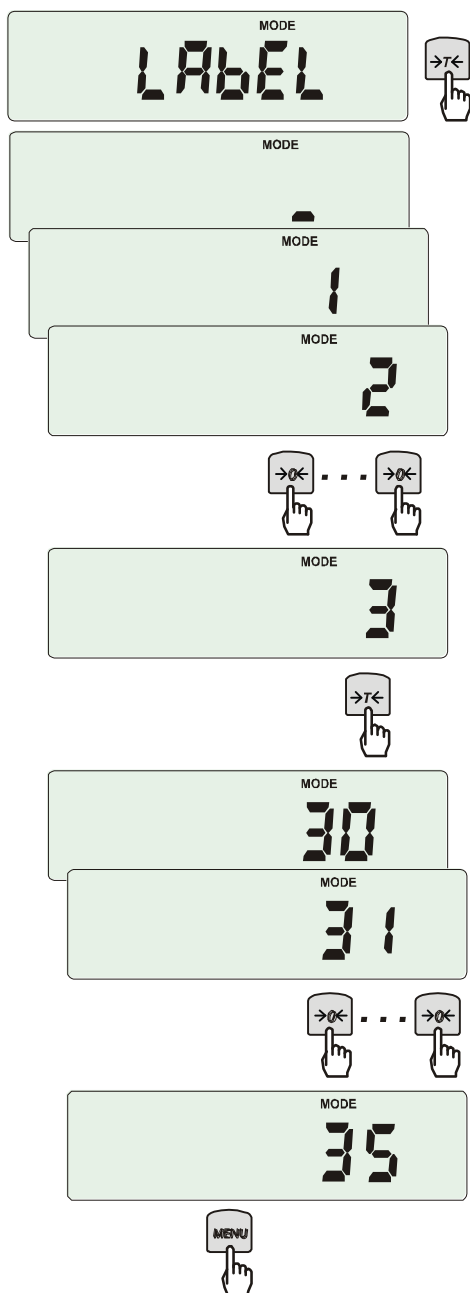

Press *MENU* button.

When *LAbEL* is displayed press  $\rightarrow T \leftarrow$  key.

Actual label number will show.

To enter new label number press  $\rightarrow T \leftarrow$  key, to exit function without number change press *MENU*.

To inscribe label number use keys:

$\rightarrow 0 \leftarrow$  - digit increase,

$\rightarrow T \leftarrow$  - next digit,

*MENU* – end.

After entering label number, putting load and pressing  $\rightarrow \leftarrow$  key will cause sending data to label printer.

Data format sent to label printer (label nr 1, language EPL-2):

US	(55 53 0D 0A)
FR"0001"	(46 52 22 30 30 30 31 22 0D 0A)
?	(3F 0D 0A)
00:00	(30 30 3A 30 30 0D 0A)
2000.00.00	(32 30 30 30 2E 30 30 2E 30 30 0D 0A)
10 g	(20 20 20 20 20 31 30 20 20 67 0D 0A)
P1	(50 31 0D 0A)

## 18.5 Weighing animals function (LOC)

The function allows weighing animal moving on the scale.

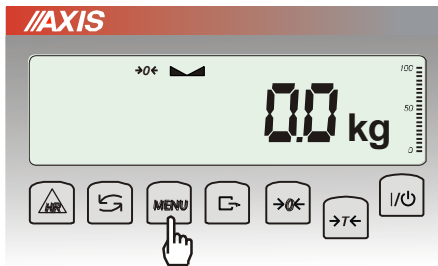

Press *MENU* key.

When *LOC* function is displayed press  $\rightarrow T \leftarrow$  key. The following options appear on display successively:

- *LOC off* – leave the function,
- *LOC on* – automatic weighing after loading the scale,
- *LOC Prn* – the measurement initiated manually by pressing  $\rightarrow T \leftarrow$  key.

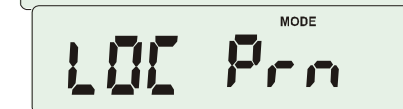
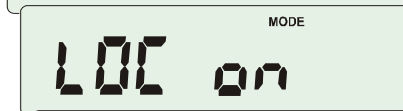
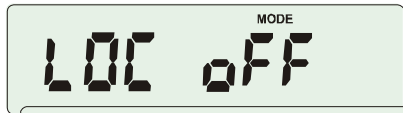

When *LOC on* is displayed press  $\rightarrow T \leftarrow$  key.

Tare the scale using  $\rightarrow T \leftarrow$  key if necessary and place the animal on the pan.

Wait until the weighing result is averaged – scale display blinks. Then scale will show stable (averaged) result and will send it through serial port.

The result remains on display for about 30 second.

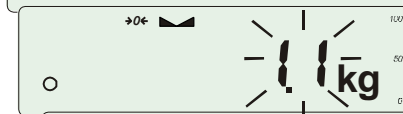
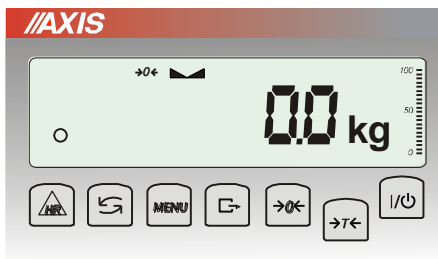

### Important notes:

1. The loads lower than Min value are not averaged.
2. In case when putting animal on scale takes more than 5s it is suggested to choose *LOC PRN* option (measurement started manually by pressing  $\rightarrow T \leftarrow$  key).

## 18.6 Maximum value indication function (UP)

This function allows holding maximum (or minimum) value that is indicating at the moment.

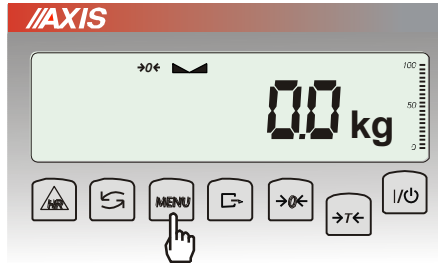

Before measurement scale should be tared.

Function has following options:

-UP OFF – function off,

-HIGH – holding maximum value,

-LOW – holding minimum value.

Pressing →T← key will cause result zeroing.

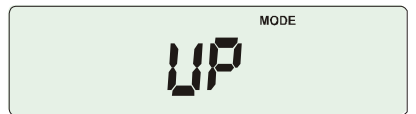

**Note:**

Autozeroing function and the stabilisation indicator are deactivated when UP function is running.

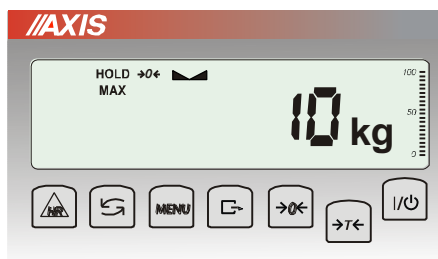
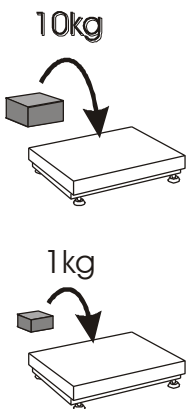
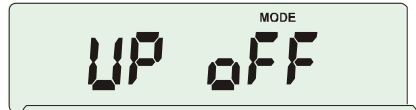

## 18.7 Force measuring function (nEWton)

Function activation causes displaying result in force units (N).

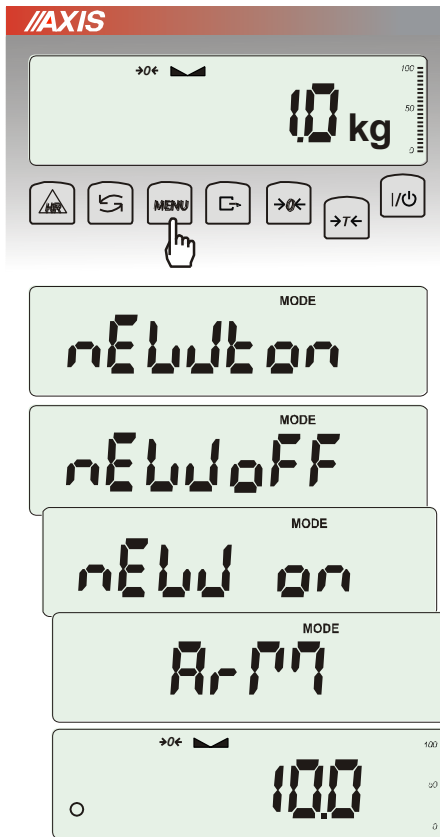
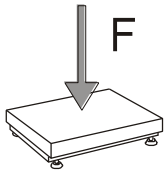

Press *MENU* key.

Using  $\rightarrow T \leftarrow$  key choose *NEWto* function.

Function has several options:

- *nEW off* – function off,
- *nEW on* – measurement in Newtons,
- *ArM* – torque measurement (arm length should be inscribed in meters using  $\rightarrow T \leftarrow$ ,  $\rightarrow 0 \leftarrow$  and *MENU* keys).

### **Attention:**

Units conversion from mass (kg) to force (N) is made for acceleration of gravity ( $g=9,80665\text{m/s}^2$ )

**Note:**  $1\text{N} \approx 0,1019\text{kg}$

### 18.8 Total weight function (total)

The function allows calculating total weight for series of measurements, which can be greater than scale capacity. It allows calculating total weight as well as average value.

Press **MENU** key.

When *total* is displayed press **→T←** key.

The following options will appear successively:

- *tot Prn* - report printout without clearing total register,
- *tot OFF* - clearing total register, report printout and leaving the function,
- *tot □* - working with receipt printout after each measurement,
- *tot* - working without receipt printout,
- *tot CFG* – saving measurement mode (using **↵** key: *Manual*, after taking off the load : *auto*).

Press **→T←** key when *tot □* is displayed.

Perform measurement series by pressing **↵** key for storing results into total register.

In order to print and display results enter the function by choosing *total* and *tot Prn* option from menu.

The results are displayed in the following sequence:

- total weight (SUM ≡),
  - number of registered measurements (n),
  - average value (=),
- regarding that moving to display successive result is performed after pressing **↵** key.

*Attention:* In scales with LED display SUM sign is replaced by “≡”.

In order to go back to total weighing without zeroing total register press **↵** key several times.

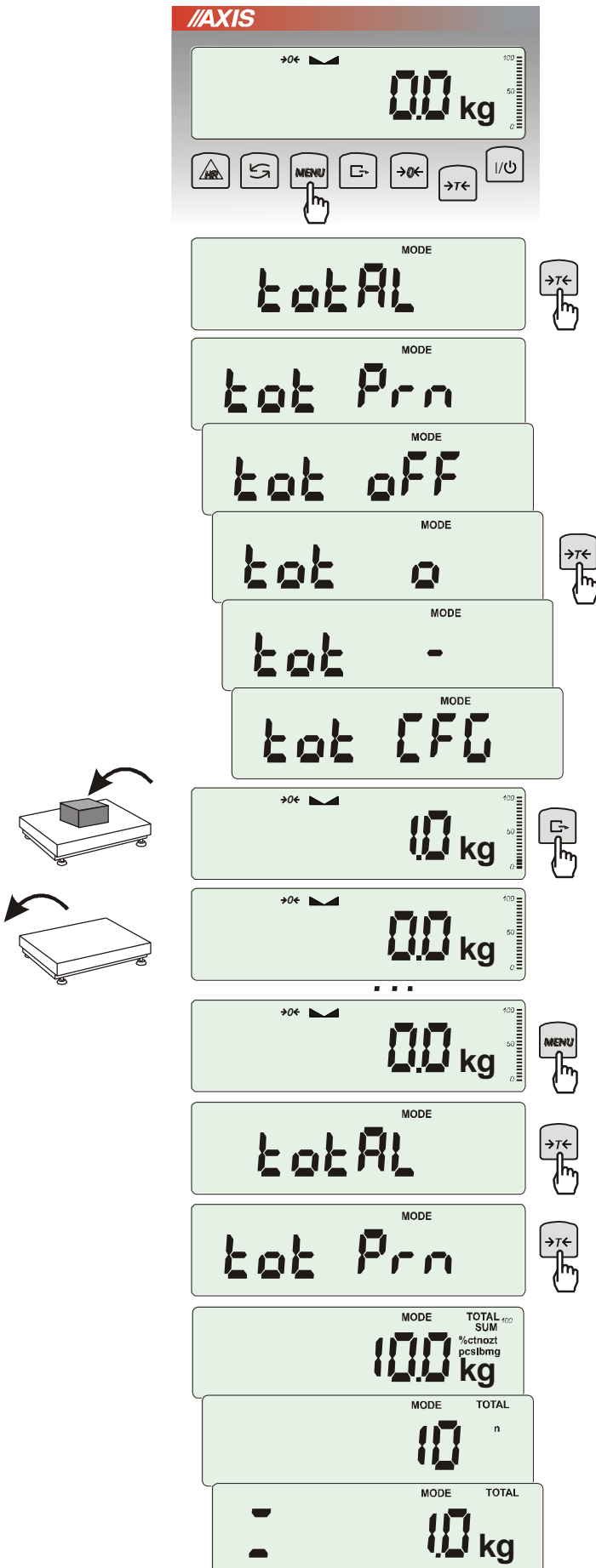

To leave the function with clearing total register, select *totAL* function from menu and choose *tot oFF* option. Scale prints the communicate informing about clearing registers.

The form of standard receipt (measurement number and weight) after each measurement:

1	3 g
2	5 g
3	3 g
4	4 g

*Print* configuration option (chapter 17.5) enables to extend standard receipt form.

Report form (total weight, number of measurements, average weight):

TOTAL	=
N	=
AVERAGE	=

**Note:**

*When the scale doesn't have an internal clock, Date and Time do not appear on printout.*

*Maximum number of measurements is 99 999.*

*Maximum total load 99 999 000d.*

*The weighing unit of the total value from the register (Total) is the same as the weighing unit stated on the keypad or is 1000 times greater, what is signalled by "o" indicator at the left of the display.*

*If the registered value is too big to be displayed, "E" communicate appears on the display. If the number of series is too high and cannot be displayed, "Err1" communicate appears on the display*



## 18.9 Checkweighing function (*thr*)

This function allows comparing weighing result with two programmed reference values: lower and upper threshold. Comparison result is signalled with indicators (MIN, OK, MAX) and sound signal generated when threshold values are exceeded.

If comparison result is:

- smaller than zero threshold – no signal,
- smaller than lower threshold – the scale signals MIN (yellow colour),
- between threshold values - the scale signals OK (green colour, with the short sound signal),
- greater than upper threshold - the scale signals MAX (red colour, long sound signal).

The checkweighing results can be use to control:

- optical indicator (*Indication mode*),
- batching devices (*Batching mode*).

Standard scale is set for cooperation with optical indicator.

On outputs P1-P3 (*Relays socket*) short-circuit states appear as result of comparison scale indication with threshold values.

On the chart below output states are shown during increasing load on the scale for both working modes:

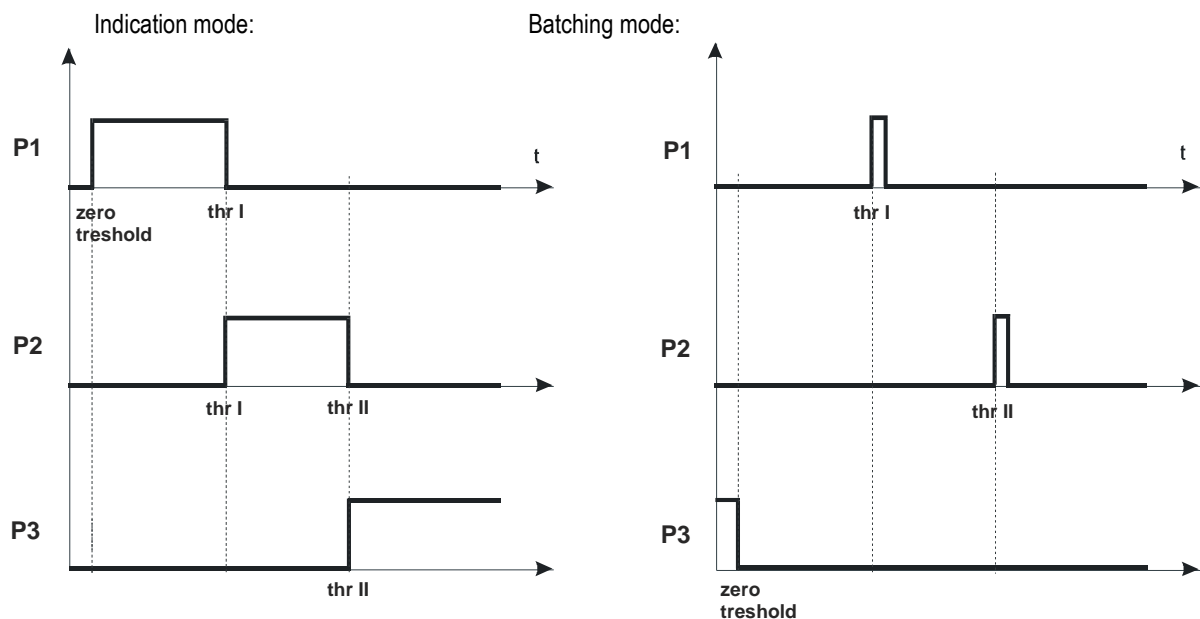

In *Batching mode* on P1 (thr I) and P2 (thr II) outputs short-circuit impulses appears for time of 0,5s. On P3 (zero) output short-circuit state appears when indication does not exceed threshold value signalling zero load.

**Operation sequence:**

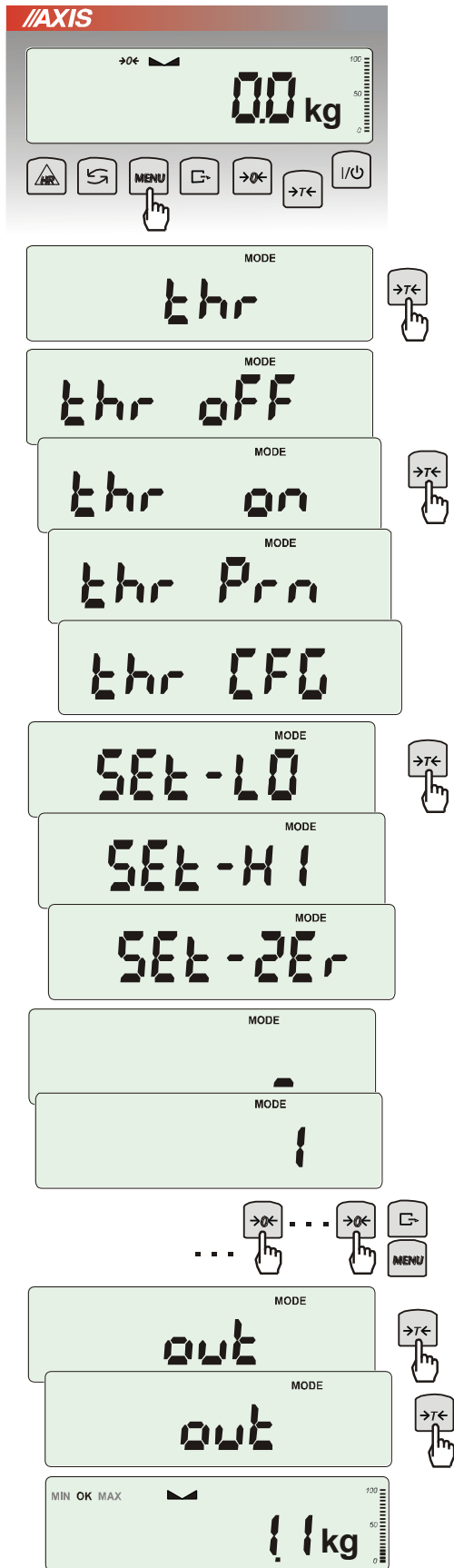

Press *MENU* key and choose *thr* pressing  $\rightarrow T \leftarrow$  key.

The following options are displayed successively:

- *thr off* – deactivate the function,
- *thr on* – activate the function,
- *thr Prn* – check last threshold values (press  $\square$  key several times),
- *thr CFG* – choose *Relays* socket mode:  
*IMPULS* – *Batching* mode  
*SIGnAL* – *Indication* mode  
*out*.

Choose *thr-on* option using  $\rightarrow T \leftarrow$  key. The following options for entering thresholds are displayed:

- *SEt-LO* - set lower threshold value,
- *SEt-HI* - set upper threshold value,
- *SEt-ZEr* - set zero signalisation threshold.

Using  $\rightarrow T \leftarrow$  key select *SEt-LO* option.

Set lower threshold value using the following keys:

- $\rightarrow 0 \leftarrow$  - digit increase,
- $\square$  - decimal point,
- $\rightarrow T \leftarrow$  - move to next digit,
- MENU* - finish.

Then select *SEt-HI* option and enter upper threshold value.

Choosing *SEt-ZEr* option will enter zero signalisation.

Choosing *out* will end inscribing thresholds. Choosing again *out* will start *thr* function.

To change *Relays* socket mode use *thr CFG* option. Default option is *Indication*.

To leave the function, press *MENU* key and then choose *thr* and *thr off* options..

Relays connection diagram:

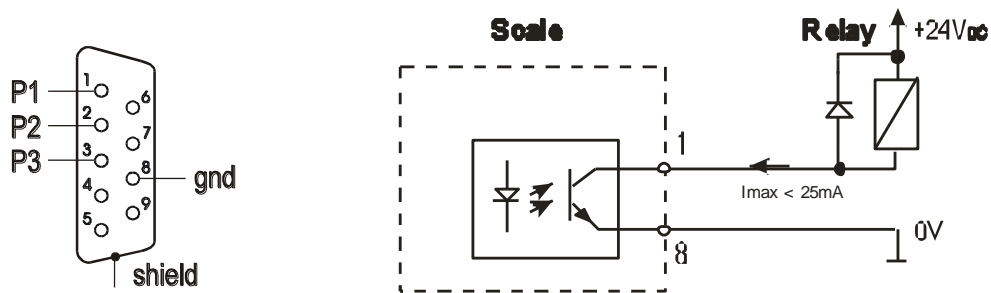

Relays output is the open collector transistor output with load capacity 25mA / 24V. Transmitter inputs must be protected with diodes, e.g. 1N4148.

It is advised to use MS3K/P electronic board (sold separately), consisting of RM96P transmitters, with DC24V input voltage and AC250V, 3A output.

### **Important notes:**

1. After switching the scale on, both thresholds are set to maximum values.
2. When setting upper threshold value, pay attention that its value is not below lower threshold value.
3. Setting lower and upper threshold value is possible after sending appropriate orders from computer, what is described in scale user manual.

## 18.10 Setting date and time function (dAtE)

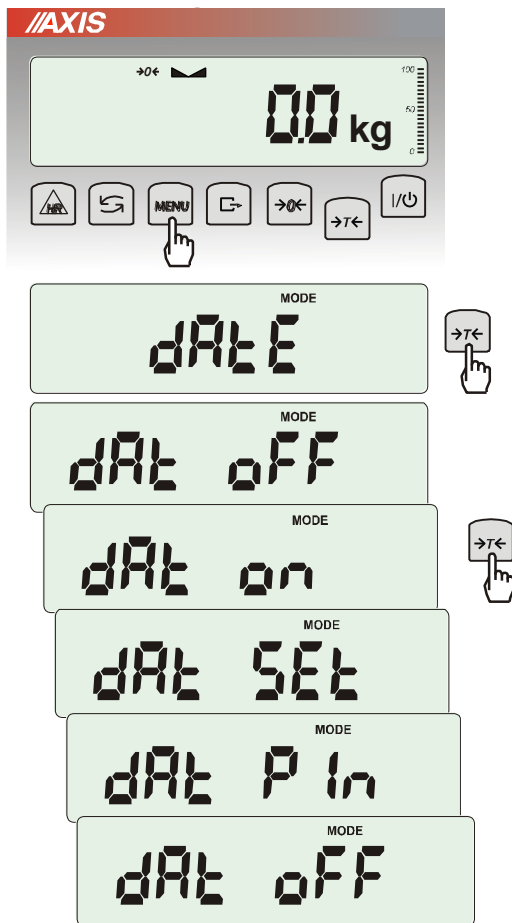

The function allows setting current date and time of scale internal clock and mode of its use.

The function has the following options:

- *dAt oFF* – deactivate date and time during printout of current weighing result,
- *dAt on* – activate date and time during printout of current indication (↵ key),
- *dAt SEt* - change current date and time,
- *dAt PIn* – data and time secure password (to prevent from changing date and time by unauthorized personel),
- *dAt For* – data printout in *USA* or *EU* format.

The example at the left presents how to set current date and time using *dAt SEt* option.

After setting proper date and time activate it with *dAt on* option.

*UE*: rrrr-mm-dd gg:mm

*USA*: mm-dd-rrrr gg:mm AM/PM

(gg – hours, mm – minutes, AM – before noon, PM – after noon, mm - month, dd - day, rrrr - year).

**Attention:** Inscribing non-zero *PIN* value causes showing *PIN* sign during next date and time changing and inscribing 4 digit code is necessary. (using keys →0←, →T← and *MENU*).

### 18.11 Radio communication channel choice function (rF CHn)

Function enables choosing radio communication channel between the scale and a pilot. In scale and in pilot the same radio channels must be chosen. Function should be used when communication is disturbed by other devices that use the same communication channel.



Press *MENU* key and choose *rF CHn* by pressing →T← key.

The following communicates will appear on display: Na wyświetlaczu pojawią się kolejno:

- *CHn 01* – channel 1,
- *CHn 02* – channel 2
- ...
- *CHn 16* – channel 16
- *out* – out without changing channel.

In default setting channel 01 is on.

## 18.12 Charging accumulators function (bAttErY)- option

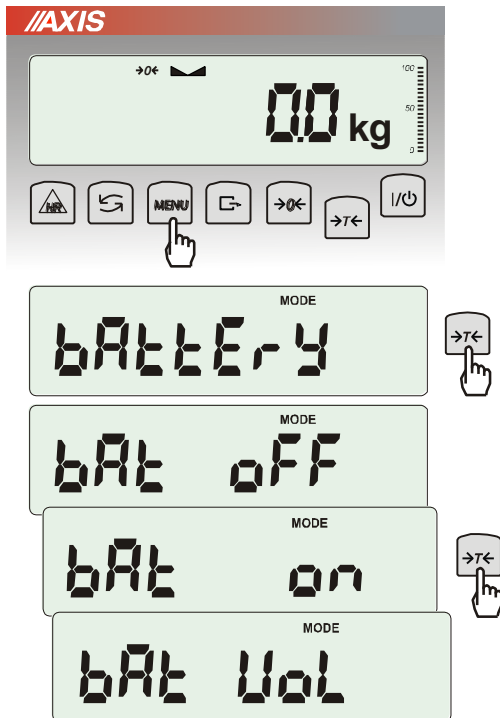

*bAttErY* function allows switching on or off charging accumulators during work with feeder and checking their power level.

The function has the following options:

- *bAt OFF* – charging off (option required if ordinary batteries are used !!!),
- *bAt on* – charging on, accumulators are being charged even after switching scale off using I/ ⏻ key,
- *bAt Vol* – reading power level of accumulators in % (go back to mass indication pressing *MENU* key),
- *out* – leave without changes

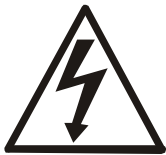

An attempt of charging ordinary batteries can cause serious damage of the scale.

### 18.13 Automatic switching off the scale function (AutoOFF)

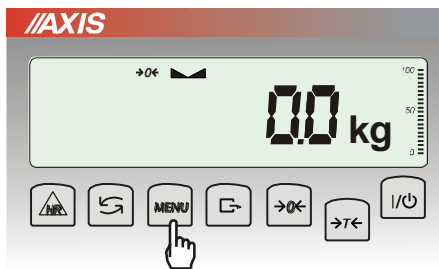

The function is helpful in scales supplied from accumulators. The function causes scale to switch off automatically.

Press *MENU* key.

When *AutoOFF* is displayed press  $\rightarrow T \leftarrow$  key.

The following options appear successively on display:

- *AOF oFF* – deactivate function,
- *AOF on* – activate function- scale turns off after 5 minutes of not making any actions,
- *AOF bAt* – as above but only when supplied from accumulators.
- *Out* – out without changes.

## 18.14 Statistical calculations function (StAt)

This function evaluates from series of measurements (max 1000) statistical parameters of weighting process.

Adding successively measurements to register is automatic and it occur after the scale is loaded and its indications stabilize.

After each loading printout is made with: number of measurements, result, date and time (if clock is installed and the function is activated).

For the obtained measurements series the scale evaluates:

- n                                    -number of samples
- sum x                                -sum of all samples  $sum\_x = \sum x_n$
- $\bar{x}$                                     -average value (sum x)/n
- min                                    -minimal value from n samples
- max                                    -maximal value from n samples
- max-min                               -maximal value minus minima value
  
- S                                        -standard deviation  $S = \sqrt{\frac{1}{(n-1)} \sum_n (x_n - \bar{x})^2}$
- srel                                    -variance factor  $srel = \frac{S}{x}$

Statistical calculations results can be printed.



**Order of operations:**

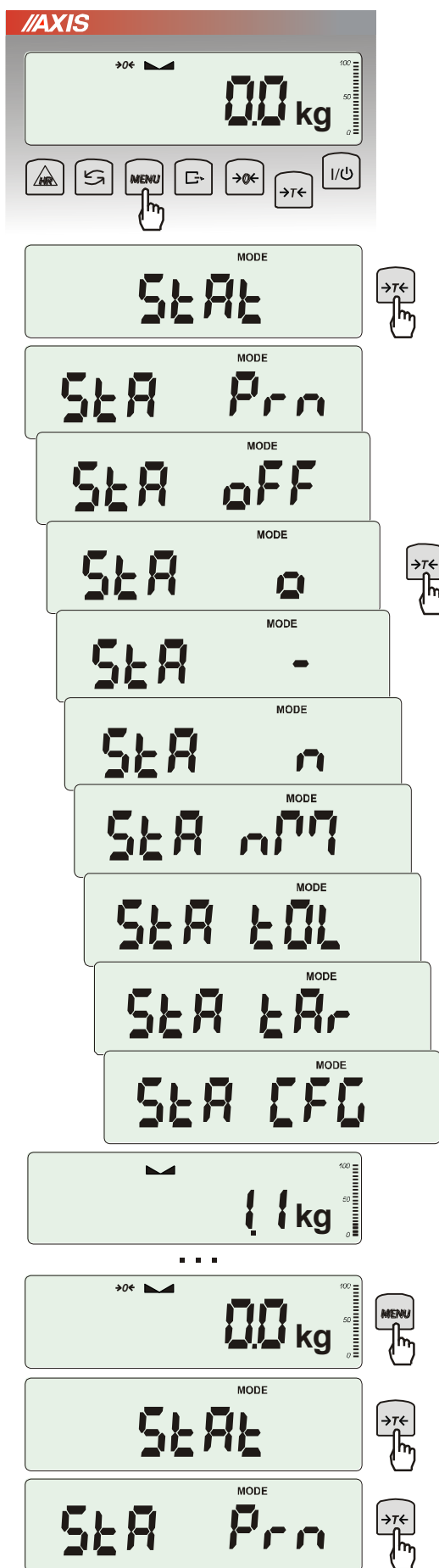

Press MENU key.

When StAt is displayed press →T← key.

The following options are displayed:

- StA Prn – monitoring and printout of statistical data,
- StA oFF – deactivate function,
- StA □ – activate function, work with printout of chosen weighting results,
- StA - - activate function, work without printout,
- StA n – maximal samples value,
- StA nM – inscribing nominal value for statistics,
- StA tOL – inscribing tolerance in %,
  - StA tAr – automatic tare on/off
- StA CFG – function configuration:
  - Auto – Automatic work (samples are confirmed after loading the scale and indication stabilization.),
  - ManuAL – manual work (confirmation is made by pressing ↵ key).
- out – exit from function.

Remember first to inscribe nominal weight value and tolerance (mentioned above).

After that, push →T← key when StA o is displayed.

Put on successive objects on the pan (remove after indication stabilization) in order to add them to measurements register.

In order to obtain printed statistical results from measurements series press MENU key and →T← key when StAt is displayed and later StA Prn.

After printout two options are enabled:

- rESET – erasing results,
- Contin – continuation.

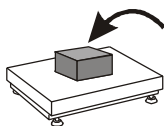

Pressing  key printouts estimated values and histogram :

Nominal - nominal value,

Tolerance - accepted value in percentage.

N - number of sample

IN TOL. – number of samples in toleranc

-TOL – amount of measurements  
under allowable lower value

+TOL – amount of measurements above  
allowable upper value

TOTAL - sum of weights of all n samples

AVERAGE – average weight as (Total)/n

MIN – minimum weight in n samples

MAX– maximum weight in n samples

ST. DEV. – standard deviation

ST. DEV.% – standard deviation percentage

To finish work with this function and zeroing result register press MENU key and then when StAt. and Sta oFF is displayed press →T← button.

Statistics function cooperation with computer and Printer. Scale can be equipped with two serial ports marked as RS232C-I (computer) and RS232C-II (printer). After each data printout by printer identical set of data is sent to computer. After sending by computer initialization signal S A CR LF (53h 49h 0Dh 0Ah) the scale sends to computer statistic data enclosed in histogram.

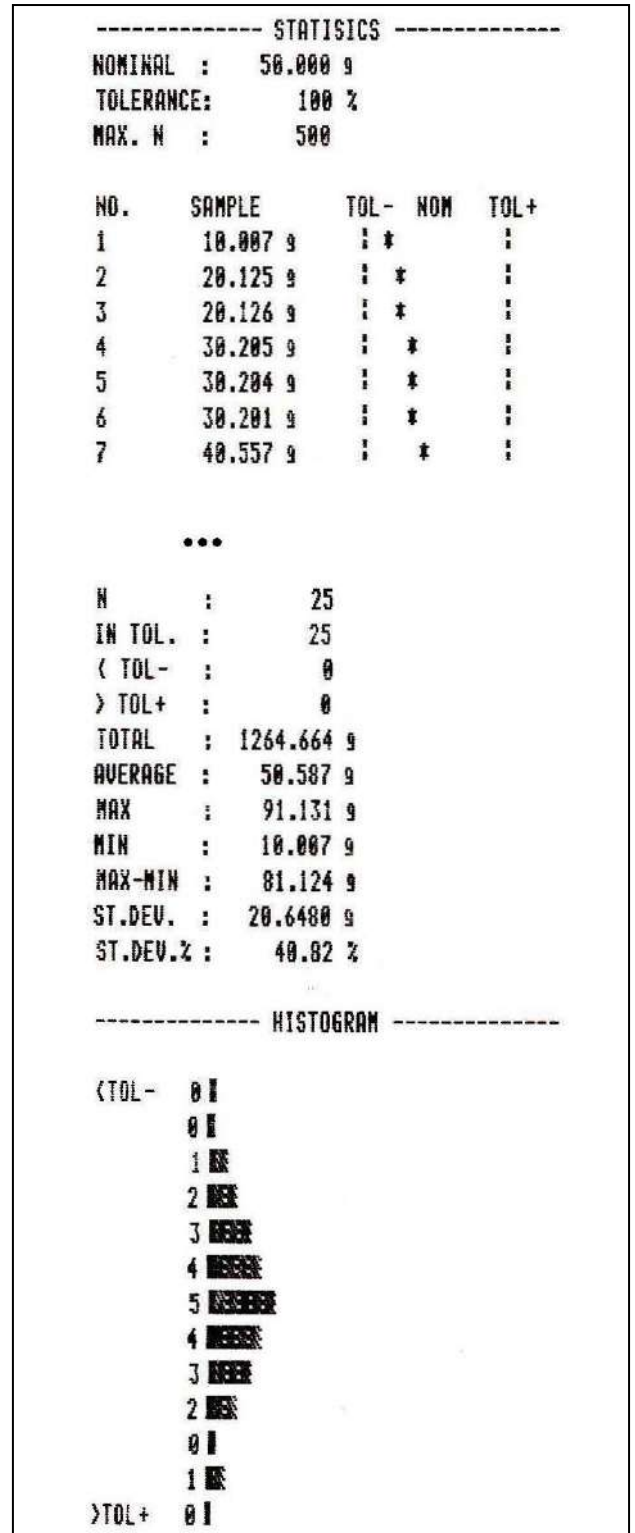

### 18.15 Paperweight calculation (PAP)

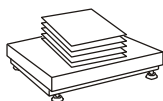
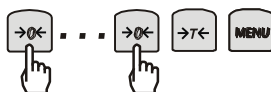
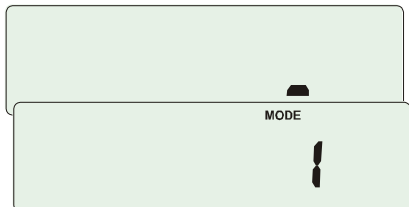
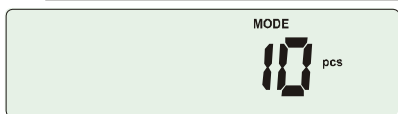
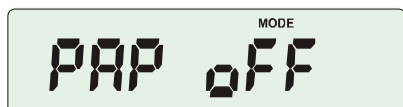
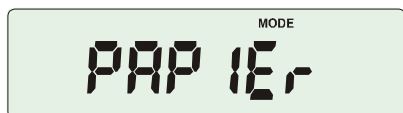
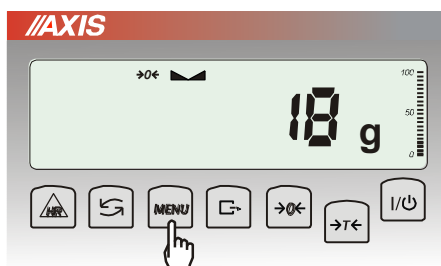
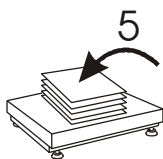

This function enables to calculate paperweight of 1m<sup>2</sup> of paper basing on samples of known area. For quick access, the function is accessible directly by pressing *MENU* key.

The balance must be tared just before the measurement.

Place the specific sample quantity of the same area (possible values: 1, 2, 5, 10, 20, 50, 100).

Press *MENU* key to access Function Menu. To enter the function press  $\rightarrow T \leftarrow$  key when *PAPER* is displayed.

Following options show on the display:

- *PAP oFF* – turn off the function,
- *PAP on* – turn on,
- *PAP n* – inscribing number of paper pieces on pan,
- *PAP ArE* – inscribing surface of single piece (in m<sup>2</sup>)

Press  $\rightarrow T \leftarrow$  key when *PAP n* and *PAP ArE* is displayed.

Enter number of samples using:

- $\rightarrow 0 \leftarrow$  -increasing digit,
- $\rightarrow T \leftarrow$  - next digit,
- MENU* – end of inscribing.

Press  $\rightarrow T \leftarrow$  key when *PAP ArE* is displayed. Enter area of a single sample (as above).

The result of paperweight measurement is finished with „o” mark pointing g/m<sup>2</sup> unit.

In order to finish work with function press *MENU* and then using  $\rightarrow T \leftarrow$  key choose *PAPER* and *PAP oFF*

**Note:** “PAP Err” communicate marks that wrong values were inscribed in *PAP n* or *PAP ArE*.

## 19. Troubleshooting and maintenance

1. The scale should be kept clean. The balance must be kept clean and protected from dust, and aggressive liquids. In order to clean it is recommended to wipe the scale with cloth soaked in soapy water and then dry.
2. Take care that no dirt gets between the platform and the scale base. If found any, remove the pan (lift it up), remove dirt and then replace the pan.
3. In case of improper operation caused by short-lasting power supply decay, unplug the scale from the mains and then plug it again after few seconds.
4. If the scale is switched on with empty pan and "SErvic(e)" communicate appears, the load cell has been mechanically damaged.
5. It is forbidden to make any repairs by unauthorised persons.
6. To repair the scale, please contact our nearest service.

### **Error communicates:**

Communicate	Possible cause	Remedy
<i>C-1 ... 6</i> (over 1 min.)	selftests failed	if displayed more than 1 minute, contact an authorised service
unLOAD /SErvic€	the scale was switched on with loaded pan	remove a load from the pan
	mechanical damage of the load cell	contact an authorised service
<i>L</i>	pan missing	put the pan on
	mechanical damage	contact an authorised service
<i>H</i>	overloading	remove the load from the pan
	mechanical damage	contact an authorised service
 indicator does not appear	unstable ground vibrations air flows	place the scale on a stable ground not affected by mechanical vibrations and airflows
	scale is damaged	contact an authorised service
- - - - -	taring in progress	as above
- -	taring could not be finished (the load is too small or B\G key was used)	zero the scale or press B\G key again
- -	the load is too big to be zeroed	tare the scale (→T←)

## Declaration of Conformity CE

The last two digits of the year in which the CE marking was affixed: 16

We:

**AXIS** Spółka z o.o. 80-125 Gdańsk, ul. Kartuska 375B

confirm with all responsibility that weighing meters:

**ME-01**

marked with CE mark comply with the following:

1. EN 61010-1:2004 standard Safety requirements for electrical equipment for measurement, control and laboratory use. General requirements harmonized with the directive 2006/95/WE (Low Voltage Directive),
2. EN 61000-6-1:2008 Electromagnetic compatibility (EMC) – General requirements
3. EN 61000-4-3:2007+A1:2008 Electromagnetic compatibility (EMC) – 4-3 part
4. EN 55011:2007+A2:2007

Additional information:

- Conformity evaluation for the Directive 2006/95/WE and 2004/108/WE was carried out by Research Laboratory of Electrotechnology Institute Division Gdańsk, accredited by PCA,

Per pro Director of AXIS Sp. z o.o.:

Production Manager

Jan Kończak



Date: 30-10-2015